

DALI-2 4Ch E-RM

Datasheet

DT7 switching module



4-channel module

for control of

4 relays via the

DALI Bus (DT7)

Art.Nr. 86450563-HS



DALI-2 4Ch E-RM DT7 Switching Actor

Overview

- 4 channel electronic relay module for direct control of 230V AC loads via DALI
- for easy connection of switched loads without a DALI input to a DALI system
- device functionality corresponds to the standard for DALI Device Type 7 – switching function
- each channel has its own DALI address (Device Type 7)
- Configurable behaviour for power-up and bus supply failure
- Simple configuration via DALI-Cockpit software tool and a Lunatone DALI interface (e.g.: [DALI-2 USB](#); [DALI USB](#), [DALI-2 WLAN](#), [DALI-2 Display](#), [DALI-2 IoT](#), [DALI 4Net](#), [DALI SCI RS232](#))
- DIN rail module (1DU)



Specification, Characteristics

type	DALI-2 4Ch E-RM
article number	86450563-HS
input: L, N	
input type	mains
marking terminals	L, N
input voltage range	230 V
input voltage frequency	50-60 Hz
Switching power max.	4 x 10W
input: DA, DA	
input type	DALI control input
marking terminals	DA, DA
input voltage range	9,5V ... 22,5V
max. current consumption DALI	4mA
number of DALI addresses	4
output: LS1, LS2, LS3, LS4	
output type	switching output mains voltage
marking terminals	LS1, LS2, LS3, LS4, N
output voltage range	0 / 230VAC

Insulation data	
impulse voltage category	II
pollution degree	2
rated insulation voltage	250V
insulation DALI (DA,DA) / (L/N/LS1, LS2, LS3, LŞ)	reinforced isolation
insulation test voltage	3000Vac
environmental conditions	
storing and transportation temperature	-20°C ... +75°C
operational ambient temperature	-10°C ... +45°C
Rel. humidity, none condensing	15% ... 90%
general data	
dimensions (l x w x h)	98 x 18 x 56 mm
mounting	DIN rail, built-in, integration in protection class II devices
rated max. temperature t_c	60°C
expected life time @ t_c	100.000 h (45°C)
protection class	II in intended use
protection degree housing	IP40
protection degree terminals	IP20
behaviour after power up	configurable
terminals	
connection type	screw terminal
wire size solid core	0,5 ... 2,5 mm ² (AWG20 ... AWG14)
wire size fine wired	0,5 ... 2,5 mm ² (AWG20 ... AWG14)
wire size using wire end ferrule	0,25 ... 1,5 mm ²
stripping length	7 mm / 0,27 inch
locking torque	0,5Nm
actuation type	screw
standards	
DALI	EN 62386-101, EN62386-102, EN62386-205
EMV	EN 61547 EN 50015 / IEC CISPR15
safety	EN 61347-2-11 EN 61347-1
markings	DALI-2, CE, UKCA

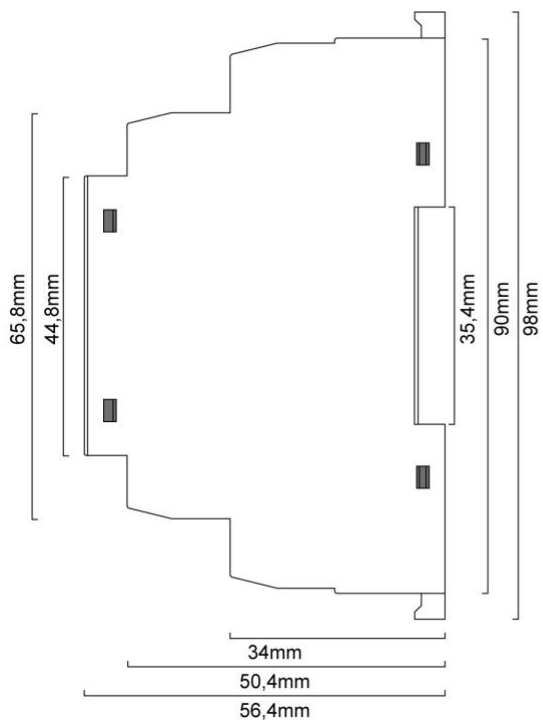

dimensions



17,5mm

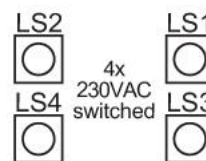
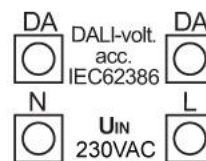

connectors

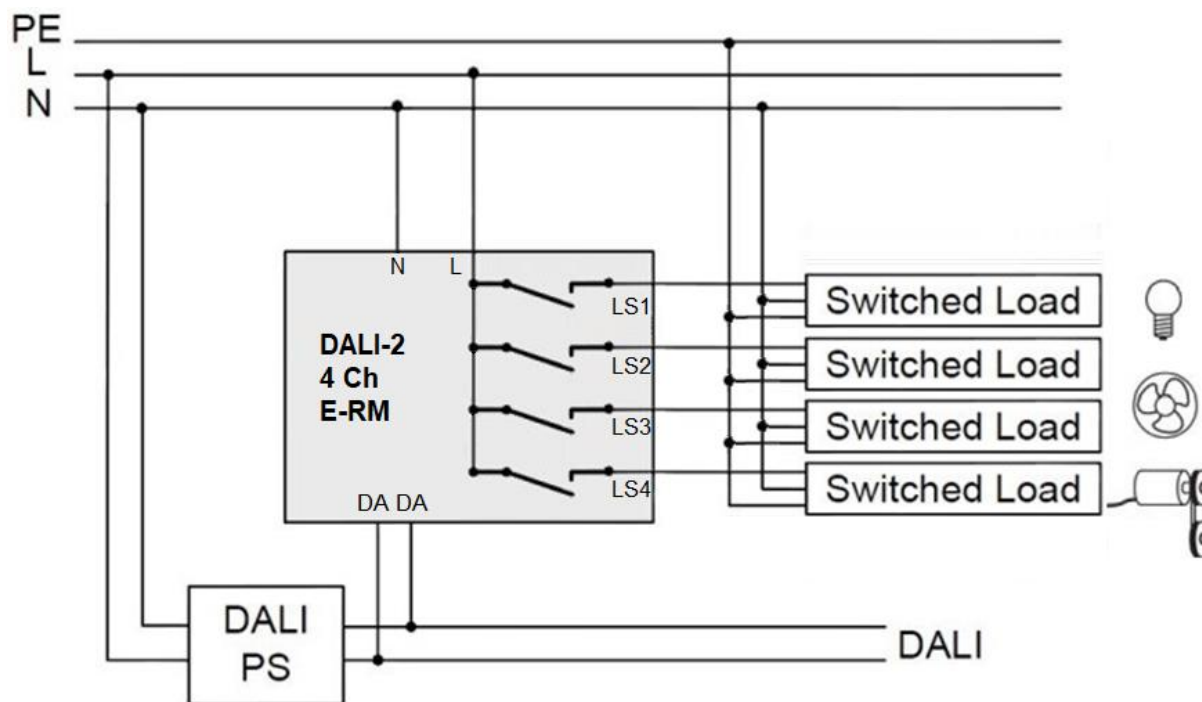

typical application

Factory Default Settings

	Factory default	DALI Standard																																																																																					
Min Level	3%	3%																																																																																					
Max Level	100%	100%																																																																																					
Power On Level	MASK (keep current value)	100%																																																																																					
Fade Time	1s	none																																																																																					
Fade Rate	89.4 steps/s	44.7 steps/s																																																																																					
System Failure Level	100%	100%																																																																																					
Scene values	<table border="1"> <thead> <tr> <th>Scene</th> <th>Ch1</th> <th>Ch2</th> <th>Ch3</th> <th>Ch4</th> </tr> </thead> <tbody> <tr><td>0</td><td>100%</td><td>0%</td><td>0%</td><td>0%</td></tr> <tr><td>1</td><td>0%</td><td>100%</td><td>0%</td><td>0%</td></tr> <tr><td>2</td><td>0%</td><td>0%</td><td>100%</td><td>0%</td></tr> <tr><td>3</td><td>0%</td><td>0%</td><td>0%</td><td>100%</td></tr> <tr><td>4</td><td>0%</td><td>0%</td><td>100%</td><td>100%</td></tr> <tr><td>5</td><td>0%</td><td>100%</td><td>0%</td><td>100%</td></tr> <tr><td>6</td><td>100%</td><td>0%</td><td>0%</td><td>100%</td></tr> <tr><td>7</td><td>100%</td><td>0%</td><td>100%</td><td>0%</td></tr> <tr><td>8</td><td>100%</td><td>100%</td><td>0%</td><td>0%</td></tr> <tr><td>9</td><td>0%</td><td>100%</td><td>100%</td><td>0%</td></tr> <tr><td>10</td><td>100%</td><td>0%</td><td>100%</td><td>100%</td></tr> <tr><td>11</td><td>100%</td><td>100%</td><td>0%</td><td>100%</td></tr> <tr><td>12</td><td>100%</td><td>100%</td><td>100%</td><td>0%</td></tr> <tr><td>13</td><td>0%</td><td>100%</td><td>100%</td><td>100%</td></tr> <tr><td>14</td><td>100%</td><td>100%</td><td>100%</td><td>100%</td></tr> <tr><td>15</td><td>0%</td><td>0%</td><td>0%</td><td>0%</td></tr> </tbody> </table>	Scene	Ch1	Ch2	Ch3	Ch4	0	100%	0%	0%	0%	1	0%	100%	0%	0%	2	0%	0%	100%	0%	3	0%	0%	0%	100%	4	0%	0%	100%	100%	5	0%	100%	0%	100%	6	100%	0%	0%	100%	7	100%	0%	100%	0%	8	100%	100%	0%	0%	9	0%	100%	100%	0%	10	100%	0%	100%	100%	11	100%	100%	0%	100%	12	100%	100%	100%	0%	13	0%	100%	100%	100%	14	100%	100%	100%	100%	15	0%	0%	0%	0%	no scene values (all scenes = MASK)
Scene	Ch1	Ch2	Ch3	Ch4																																																																																			
0	100%	0%	0%	0%																																																																																			
1	0%	100%	0%	0%																																																																																			
2	0%	0%	100%	0%																																																																																			
3	0%	0%	0%	100%																																																																																			
4	0%	0%	100%	100%																																																																																			
5	0%	100%	0%	100%																																																																																			
6	100%	0%	0%	100%																																																																																			
7	100%	0%	100%	0%																																																																																			
8	100%	100%	0%	0%																																																																																			
9	0%	100%	100%	0%																																																																																			
10	100%	0%	100%	100%																																																																																			
11	100%	100%	0%	100%																																																																																			
12	100%	100%	100%	0%																																																																																			
13	0%	100%	100%	100%																																																																																			
14	100%	100%	100%	100%																																																																																			
15	0%	0%	0%	0%																																																																																			
Ignore broadcast commands	disabled	--																																																																																					
Behaviour at DALI RESET command	set DALI Standard values, see column 2	--																																																																																					

Installation

- Das DALI-2 4Ch E-RM is suitable for DIN rail mounting, protection against shock has to be provided by an appropriate enclosure.
- The wiring should be carried out as a permanent installation in a dry and clean environment.
- Installation may only be carried out in a voltage-free state of the system and by qualified specialists. The system must also be switched off when replacing the luminaire.
- National regulations for setting up electrical systems must be followed.
- Connect power supply terminals L and N to mains voltage according to the labelling.
- Connect terminals LS1, LS2, LS3, LS4 and N to the load.
- the connection to the DALI-line (DA, DA) is polarity free.
- The DALI line may be routed together with the mains voltage (in one cable or as single wires in a tube)
- The DALI-line must not be connected to the mains or extra low voltage systems.
- The DALI wiring can be realised with standard low-voltage installation material. No special cables are required.

- Wiring topology of the DALI-line: Line, Tree, Star



Attention: The DALI-signal is not classified as SELV circuit (Safety Extra Low Voltage). Therefore, the installation regulations for low voltage apply



The voltage drop on the DALI line must not exceed 2V at maximum length (300m) and maximum bus load (250mA).

Commissioning

- After installation the DALI-2 4Ch E-RM is ready for use
- The DALI-2 4Ch E-RM can be addressed with the DALI Cockpit PC Software. When using the [DALI Cockpit Software](#), the PC must be connected to the DALI bus via a suitable interface module ([DALI-2 USB](#); [DALI USB](#), [DALI-2 WLAN](#), [DALI-2 Display](#), [DALI-2 IoT](#), [DALI 4Net](#), [DALI SCI RS232](#)). The DALI-2 4Ch E-RM is automatically recognised by the DALI Cockpit during the addressing process and listed in the device overview.
- Scene values, groups, DALI parameters and device specific settings can be configured in the DALI Cockpit, see section Function.

Function

With the DALI-2 4Ch E-RM ballasts can be integrated in a DALI-system and switched on and off by DALI commands.

Each channel is represented via a DALI address on the DALI bus and acts like a standard DALI gear for non-dimmable loads, based on the DALI specification for device type 7 (IEC 62386-208). The switching characteristic is determined by the comparison of the virtual direct arc power level (VDAP) with 4 thresholds.

The virtual dim level (VDAP) is like the dim level of DALI-ballasts and is therefore limited by MINLEVEL and MAXLEVEL and influenced by fade-time and fade-rate.

For each dim direction 2 thresholds can be defined. They are compared with the virtual dim level and as a result the output is switched on or off:

virtual dim direction	comparison of virtual dim level and thresholds	output
UP	$VDAP \geq$ UP SwitchOn threshold	ON
UP	$VDAP \geq$ UP SwitchOff threshold	OFF
DOWN	$VDAP \leq$ DOWN SwitchOn threshold	ON
DOWN	$VDAP \leq$ DOWN SwitchOff threshold	OFF

If a threshold value is set to “MASK” the threshold is inactive and does not influence the relay output.

Some examples of switching characteristics are shown in the following Figure 1. With the help of the fade time switch on and switch off delays can be realized. Configuration of the switching thresholds in the DALI Cockpit see also Figure 4.

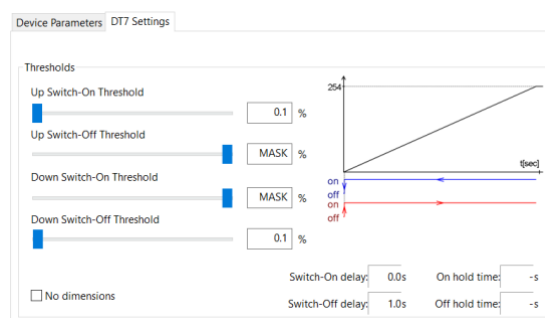

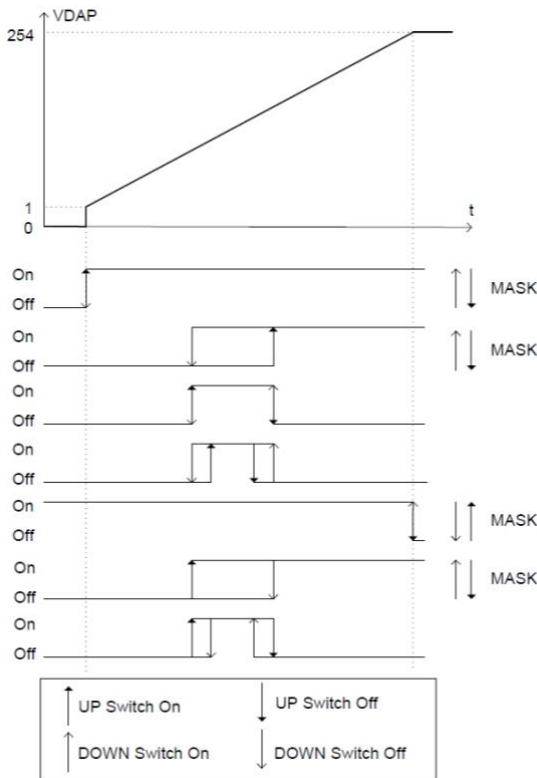

Figure 1 possible switching characteristics

Ignore Broadcast commands

The “Ignore Broadcast” setting can be used to ensure that the relay does not respond to broadcast commands on the DALI bus (group assignments are not ignored). The setting is possible in the devices overview page (see Figure 2)

Device Channel Settings

Channel specific settings such as scenes, min level, max level, power on level, system failure level,... can be made for each channel on the respective page in the DALI Cockpit.

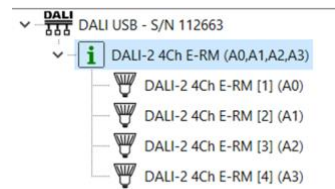

See also Figure 3 page 8

DALI Cockpit Configuration

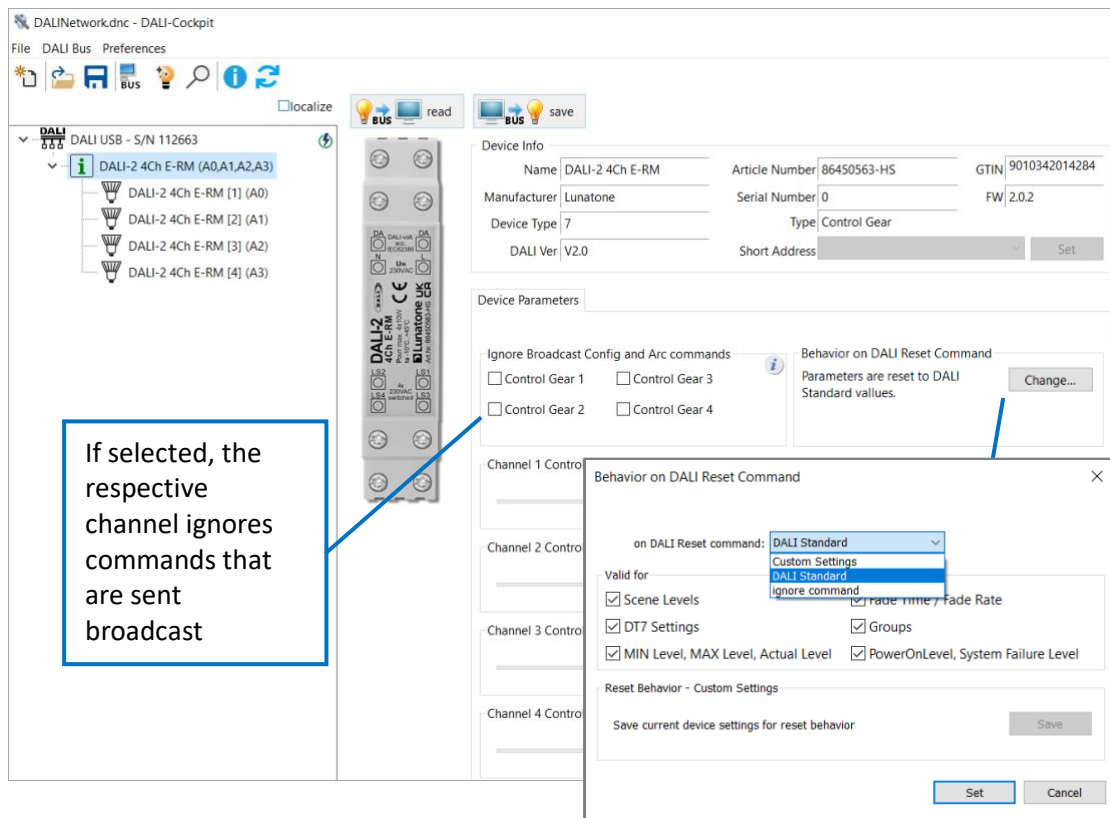

Figure 2 DALI Cockpit settings – device overview page

Adjustable DALI RESET behaviour

The response to a DALI reset command is configurable. The following options are available:

- *Ignore command*: the DALI reset command does not trigger any changes to the device settings
- *DALI standard*: the selected device settings are reset to the values defined in the DALI standard (see table 1 below - second column: DALI standard values)
- *Custom settings*: the current device settings can be saved. With a DALI Reset command, the selected parameters (6 check boxes) are then reset to these saved values.

System Failure und Power On Level

For each channel, the reaction on a system failure can be configured (keep relay state (MASK), ON or OFF). The switching behaviour after connecting the DALI bus supply can be set via the PowerOnLevel, see Figure 3 below.

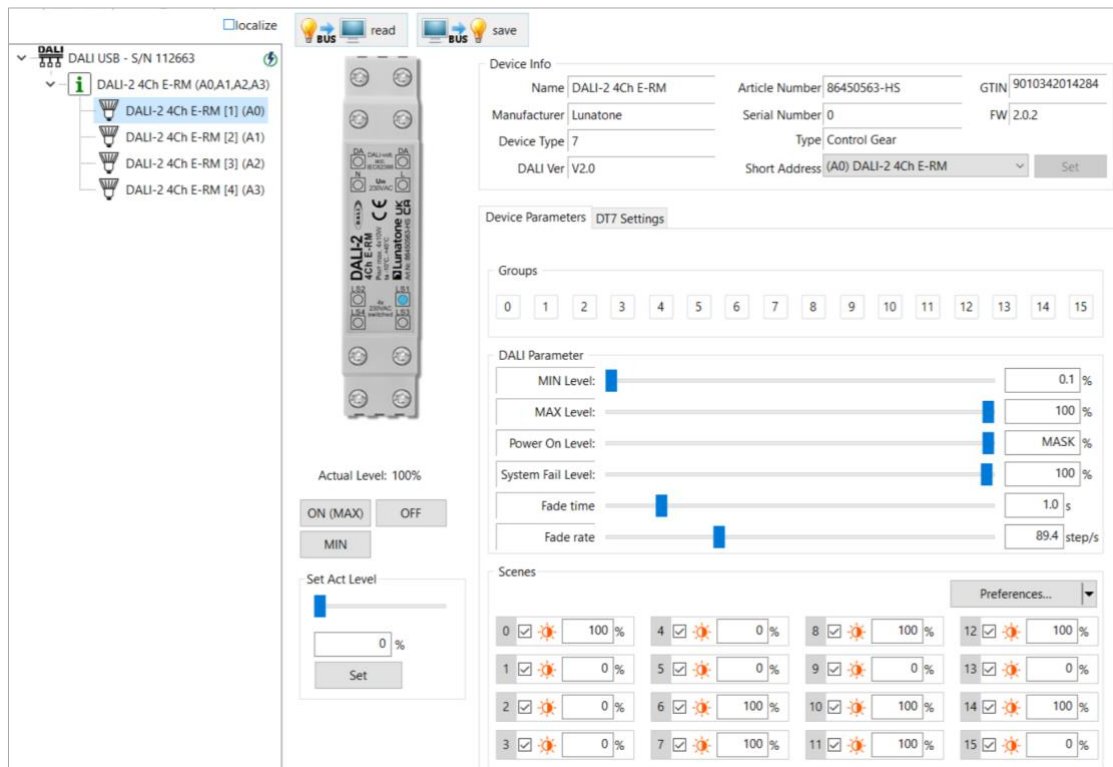

Figure 3 DALI Cockpit – device settings channel 1

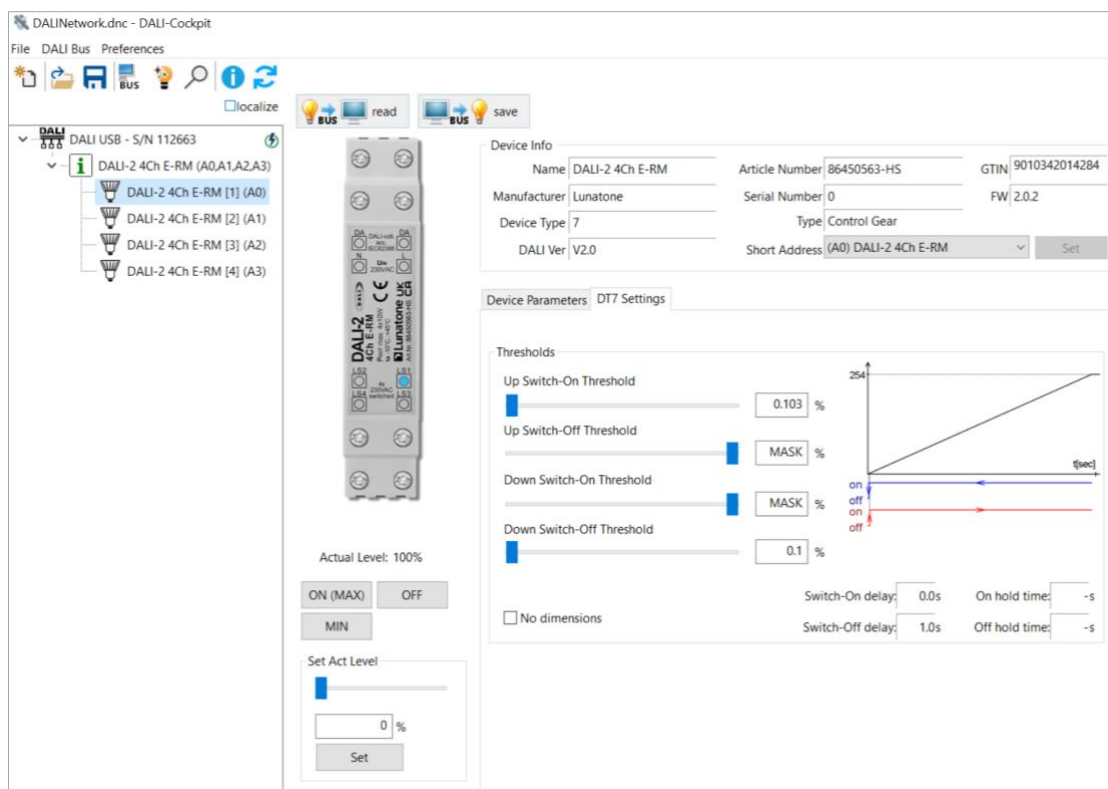

Figure 4 DALI Cockpit – device settings channel 1 DT7 settings

Purchase Order Information

Art. Nr. 86450563-HS: DALI-2 4Ch E-RM, 4-channel relay module, 4 DALI addresses, DIN rail

Contact

Technical Support: support@lunatone.com

Requests: sales@lunatone.com

www.lunatone.com

Additional Information and Equipment

DALI-Cockpit – free configuration tool for DALI systems

www.lunatone.com/en/product/dali-cockpit/

Lunatone DALI products

<https://www.lunatone.com/en/>

Lunatone datasheets and manuals

<https://www.lunatone.com/en/downloads-a-z/>



Disclaimer

Subject to change. Information provided without guarantee. The datasheet refers to the current delivery.

The compatibility with other devices must be tested in advance to the installation.