

DALI 2Ch LED Dimmer CV

Datasheet Control Gear



2-channel LED Dimmer (CV, DT6)



Art.Nr. 89453827 (4A)

Art.Nr. 89453833 (8A)

Art.Nr. 86459561 (10A)

Art.Nr. 89453830 (16A)

Art.Nr. 89453830-HS (16A DIN Rail)

DALI 2Ch LED-Dimmer CV Control Gear

Overview

- 2 channel DALI LED-Dimmer
- suitable for constant voltage LED-modules with operating voltages from 12V to 48V
- **Operating Mode DT6:** individual channel control via 2 DALI addresses
- **Operating Mode Balance&Dim:** control by 2 DALI-addresses, one for adjusting the light level and one for adjusting the channel balance (e.g. colour temperature)
- **Operating Mode Dim2Warm:** one DALI-address for simultaneous adjustment of light level and colour temperature
- **SwitchDim2:** 2 switch-inputs offer control of light level and colour without DALI
- dimming range 0.1%-100%
- adjustable PWM-frequency (122Hz/ 244Hz/ 488Hz/ 976Hz from FW version 4.6 on changed PWM frequencies: 250Hz / 500Hz / 1kHz)
- compact types for integration in luminaires or remote ceiling
- supply voltage type dependent of 12V to 28V DC or from 12V to 48V DC (according to the operating voltage of the led modules)
- type dependent max. input currents of 4A, 8A, 10A or 16A
- the maximum input current can be freely distributed between the channels
- low standby power consumption
- high efficiency
- configuration via PC-software DALI-Cockpit and DALI USB-interface
- user-friendly factory default settings

From FW Version 4.6 onward:

- DALI-2 compatible
- LED calibration for light adjustment
- Configurable RESET behaviour



Specification, Characteristics

type	DALI 2Ch Led Dimmer CV				
article number	89453827	89453833	86459561	89453830	89453830-HS
electrical data:					
supply voltage Vin	12V-28VDC	12VDC-48VDC			
maximum input current Iinmax	4A	8A	10A	16A	
control input	DALI	DALI SwitchDim2 (mains voltage)			
current consumption DALI	2mA				
number of DALI-addresses	operating mode Dim2Warm: 1 operating mode DT6, Balance&Dim: 2				
standby power consumption (12V)	~ 120 mW				

article number	89453827	89453833	86459561	89453830	89453830-HS
----------------	----------	----------	----------	----------	-------------

technical data:

power on behaviour	configurable via DALI: 0%-100% or last value			
storing- and transportation temperature	-20°C ... +75°C			
ambient temperature	-20°C to +60°C			20°C to +55°C
expected lifetime (at Tc<=75°C)	>100000h			
protection class	IP20			
max. connecting wire cross section	1.5 mm ²		1.5 mm ² , supply (V+, V-): 2.5 mm ²	2.5mm ²
dimensions (LxWxH)	40x28x14 mm	59x33x15 mm	120x30x22 mm	98x18x56 mm
housing/mounting	back box		remote ceiling	DIN rail

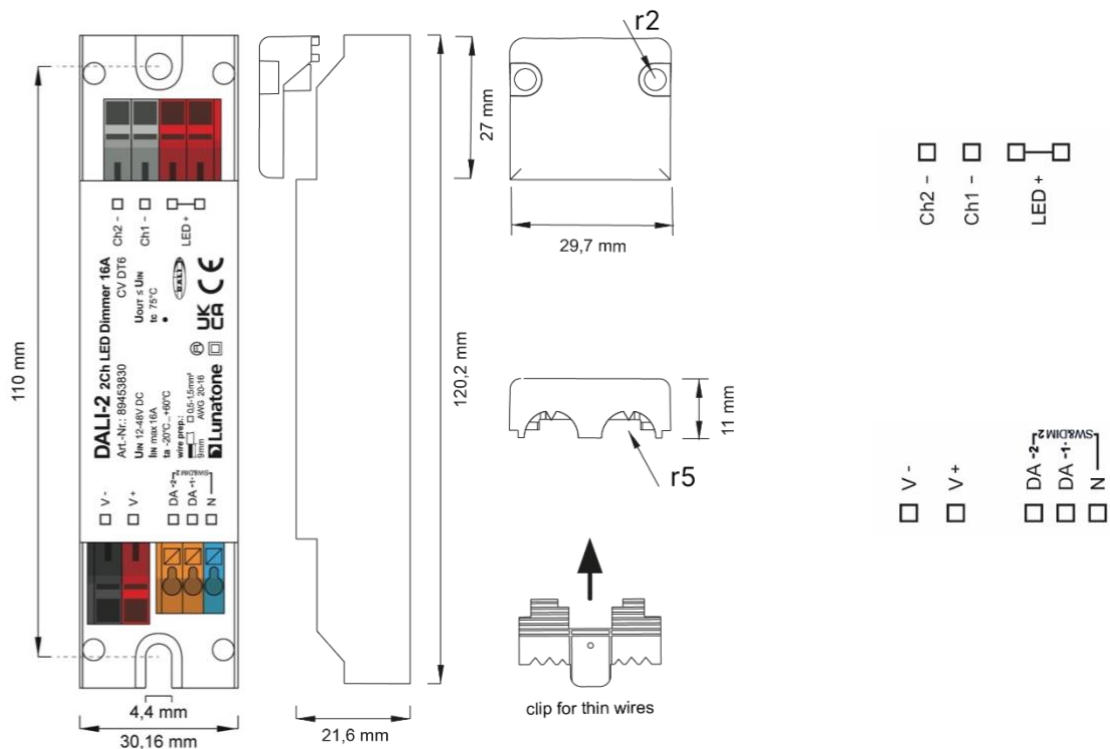

dimensions remote ceiling
Version 16A Art.Nr.: 89453830
Version 10A Art.Nr.: 86459561

connection plan remote ceiling
Version 16A Art.Nr.: 89453830
Version 10A Art.Nr.: 86459561

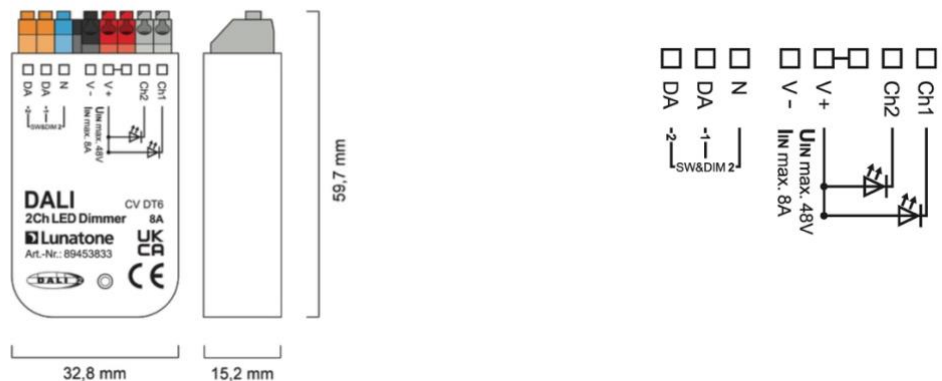

dimensions back box 8A
Version 8A Art.Nr.: 89453833

connection plan back box 8A
Version 8A Art.Nr.: 89453833

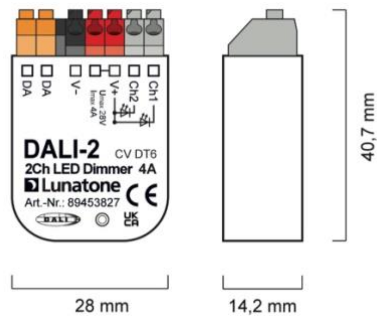

dimensions back box 4A
Version 4A Art.Nr.: 89453827

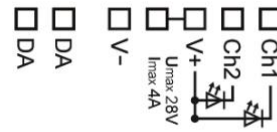

connection plan back box 4A
Version 4A Art.Nr.: 89453827

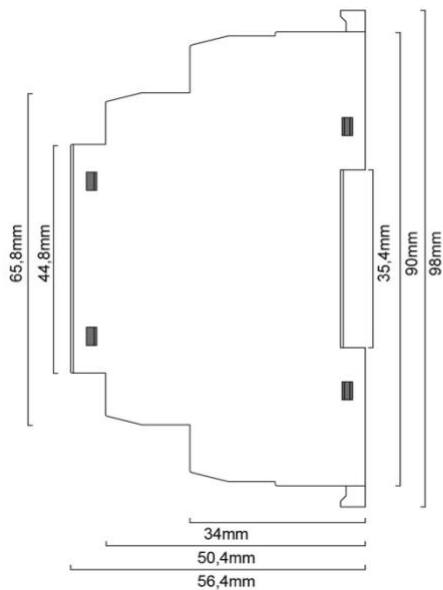

dimensions DIN rail housing
Version 16A Art.Nr.: 89453830-HS



connection DIN rail housing
Version 16A Art.Nr.: 89453830-HS

RECOMMENDATION: Care should be taken on keeping cable lengths between DC power supply and dimmer, as well as between dimmer and luminaires (Led-Strings), as short as possible. This kind of installation will minimize the influence of voltage drops.

Control via DALI (all device versions):

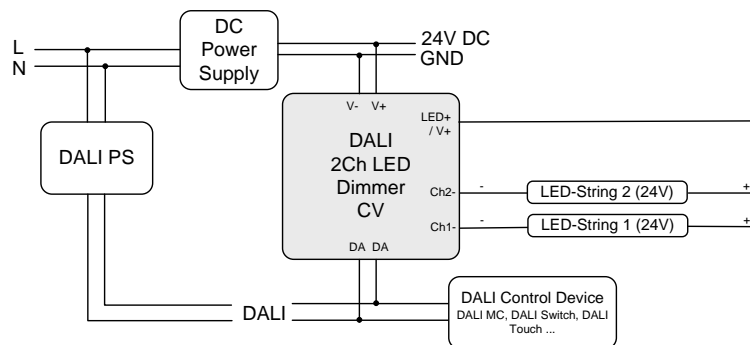

Control via SwitchDim2 (all device versions except Version 4A Art.Nr.: 89453827):

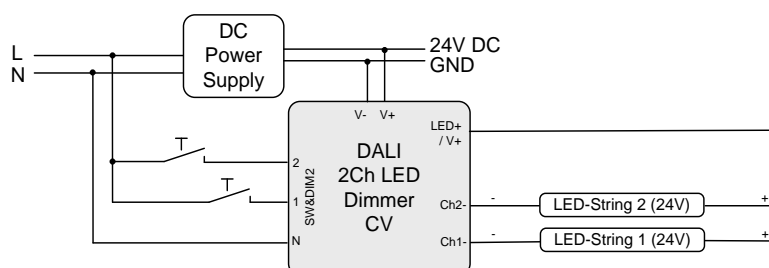

Operating Modes

The device has three operating modes, DT6 Balance&Dim, and Dim2Warm.

DT6 (factory default)

In this operating mode each channel can be controlled by its own DALI address (Device Type 6).

Alternatively, the device can be controlled using 2 switch-inputs for mains voltage (SwitchDim2):

SwD1: light level

short press: On/Off

long press: dimming

SwD2: scene selector (short press)

scene pre-set see table 1, page 9

From FW version 4.6 on Lunatone LED Dimmer are DALI 2 compatible and support DALI 2 commands.

Balance&Dim

This operating mode is also suitable for operating tunable white luminaires using two DALI-addresses. The first address controls the light level, and the second address is used for changing the distribution on the output channels (e.g. for tunable white applications or balancing direct/indirect lighting).

The Balance&Dim mode allows colour temperature adjustments without affecting the light level and vice versa. For each channel DALI-standard commands like dim up/down and DAP are used. Thus the

device can be used with all common controls and gateways (e.g. KNX). The Balance&Dim mode provides an alternative to the DT8-Tc device.

Can be operated via DALI or SwitchDim2:

DALI-address 1, SwD1: light level

DALI-address 2, SwD2: balance

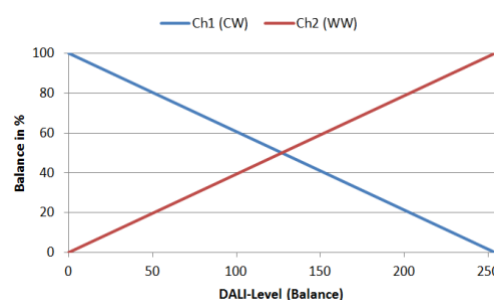

Dim2Warm

Both output channels are controlled by one DALI-address or SwD-input. The balance is coupled directly to the DALI dim level – the smaller the dim level the warmer the light.

DALI-address 1,

SwD1: Dim2Warm (Master)

short press: On/Off

long press: dimming

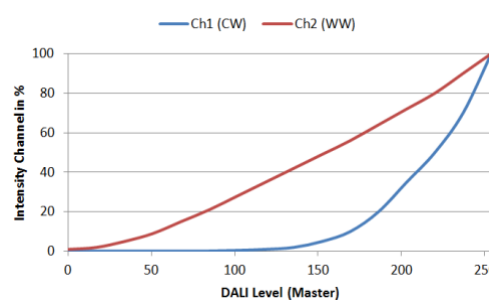

SwD2: scene selector

Selection of operating mode

With the PC-software tool DALI-Cockpit the operating mode can be easily set on the overview page:

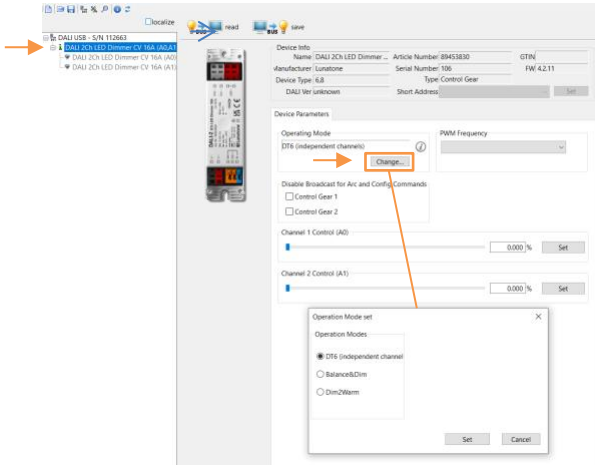

The operating mode can also be set with the DALI-command: SET OPERATING MODE (IEC 62386-102 Ed.2). When changing the operating mode, the number of used DALI-addresses might change as well, which

requires a new addressing process. In the DALI-Cockpit this address assignment is performed automatically.

Operating Mode:

Number	Operating Mode
0x0	DT6 (factory default)
0x90	DT6
0x94	Balance&Dim
0x95	Dim2Warm

Cockpit: General Settings

On the overview page, there are different control elements, depending on the operating mode (*DT6*: 2 sliders for the level of each channel, *Balance&Dim*: slider for level and balance, *Dim2Warm*: slider for input value adaption and an Edit-Function for the Dim2Warm-table). Also, the following configuration options are available.

Overview Operating mode DT6

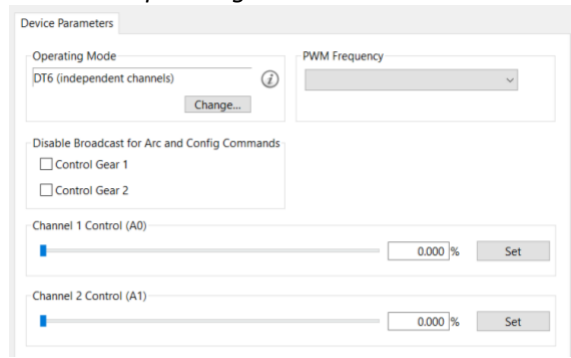

Overview Operating Mode Dim2Warm:

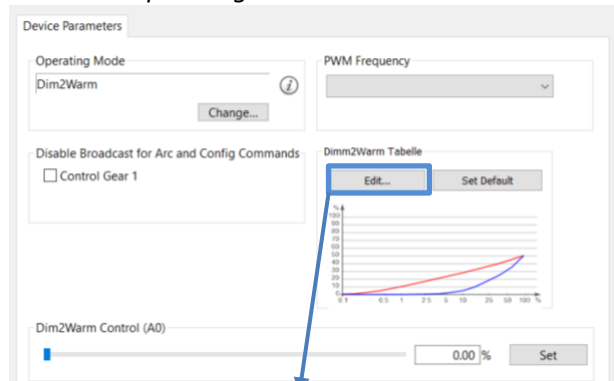

Overview Operating Mode Balance&Dim:

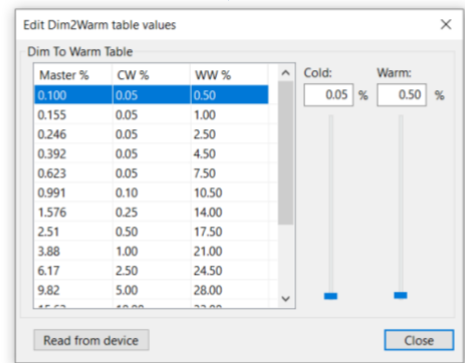
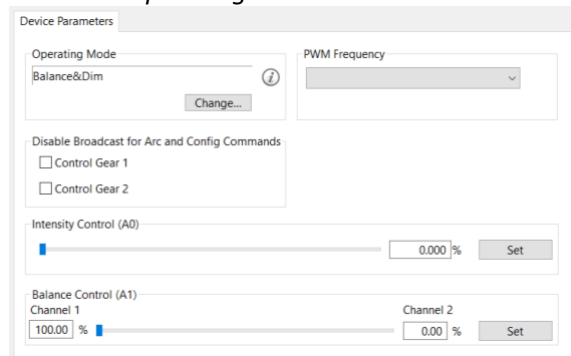

The **PWM frequency** can be selected:
 122Hz / 244Hz / 488Hz / 976Hz.
 From FW version 4.6 changed PWM
 frequencies: 250Hz / 500Hz / 1kHz.

The **broadcast control** can be deactivated for
 each channel individually.

Adjustable RESET behaviour:

From FW version 4.6 up, the response to a
 DALI reset command is configurable. The
 following options are available:

- *Ignore command*: the DALI reset command does not trigger any changes to the device settings.
- *DALI standard*: the selected device settings are reset to the values defined in the DALI standard (see table 1 below - second column: DALI standard values)

The screenshot displays the configuration interface for a DALI 2Ch LED Dimmer CV DT6. It includes a 'Device Info' section with fields for Name, Manufacturer, Device Type, and DALI Version. The 'Device Parameters' section shows 'Operating Mode' set to DT6 (independent channels) and 'PWM Frequency' set to max. quality (~1kHz). There are checkboxes for 'Disable Broadcast for Arc and Config Commands' for both Control Gear 1 and 2. Channel 1 and 2 controls are shown with sliders and 'Set' buttons. Two callout boxes explain that when broadcast is disabled, the device does not react to Arc (DAP) or configuration commands, and that the light value is set to be calibrated. Below the main interface, two windows are open: 'LED Calibration' for adjusting MIN, 33%, and MAX levels for both channels, and 'Behavior on DALI Reset Command' where 'DALI Standard' is selected, and various parameters like Scene Levels, DT8 Scene Colours, and MIN Level are checked.

Figure 1 Cockpit overview page - LED Calibration and Behaviour on DALI RESET Command

Calibration - light adjustment:

The dimming range extends from 0.1% to 100%. From FW version 4.6 on, it is possible to calibrate different light sources, with the option: LED calibration. For each channel, the MIN level (default: 0.1%) an intermediate value (default: 33%) and the MAX level (default: 100%) can be adjusted and matched between light sources.

To do this, set the desired level with the upper slider. Apply the value and start the fine adjustment by pressing the button next to it. The appropriate fine adjustments can now be made with the calibration slider below. See Figure 1., page 7.

Cockpit: Additional Settings

Besides the settings on the general page each channel can be selected separately in the component tree for individual configuration. Figure 2 below shows the available settings for each channel (these are the same for all operating modes).

Component Tree:

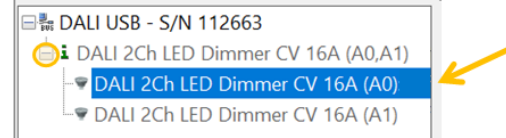

For each address the group membership, scene values and DALI-parameters can be set. In operating mode Balance&Dim, channel 2 sets the balance.

Factory Default Settings

Before the initial addressing is performed, the device can already be controlled by group addresses G0 and G1. This predefined grouping will be deleted during the first addressing procedure. Afterwards groups can be assigned as usual (e.g. with the DALI Cockpit). By sending a DALI-Reset command the device is set to DALI default values as defined in the standard.

The factory default values as well as the DALI-standard values are summarised in table 1 below.

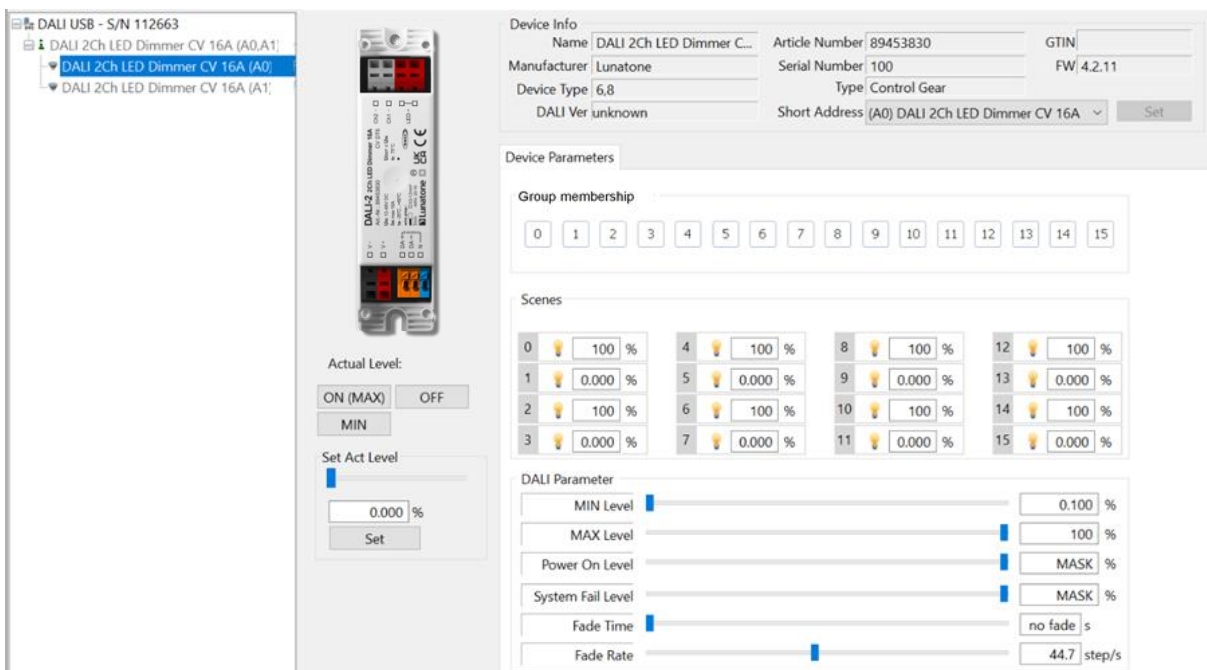

Figure 2 Cockpit settings for each channel / address

Summary of the factory default settings (delivery state):

	Factory default	DALI Standard															
operating mode	DT6	---															
switchDim2	SwD1: light level SwD2: scene selector	---															
Min Level	0.1%	0.1%															
Max Level	100%	100%															
Power On Level	MASK (last value)	100%															
System Failure Level	100%	100%															
Fade Time	1s	None															
Fade Rate	89.4 steps/s	44.7 steps/s															
PWM-Frequency	122Hz or 1kHz for FW 4.6 and up	---															
Groups before initial addressing	G0 – channel 0 G1 – channel 1	None															
Scene values	<table border="1"> <thead> <tr> <th>Scene</th> <th>Ch1</th> <th>Ch2</th> </tr> </thead> <tbody> <tr> <td>0, 4, 8, 12</td> <td>100%</td> <td>0%</td> </tr> <tr> <td>1, 5, 9, 13</td> <td>0%</td> <td>100%</td> </tr> <tr> <td>2, 6, 10, 14</td> <td>100%</td> <td>100%</td> </tr> <tr> <td>3, 7, 11, 15</td> <td>0%</td> <td>0%</td> </tr> </tbody> </table>	Scene	Ch1	Ch2	0, 4, 8, 12	100%	0%	1, 5, 9, 13	0%	100%	2, 6, 10, 14	100%	100%	3, 7, 11, 15	0%	0%	all scenes: MASK
Scene	Ch1	Ch2															
0, 4, 8, 12	100%	0%															
1, 5, 9, 13	0%	100%															
2, 6, 10, 14	100%	100%															
3, 7, 11, 15	0%	0%															
Behaviour at DALI RESET command	set DALI Standard values, see column 2	---															

Table 1 factory default settings column 1, DALI Standard settings column 2

Purchase Order Information

Art.Nr. 89453827: 2-channel LED Dimmer, CV, max. input current 4A, 12V-28V DC, back box

Art.Nr. 89453833: 2-channel LED Dimmer, CV, max. input current 8A, 12V-28V DC, SwitchDim2, back box

Art.Nr. 86459561: 2-channel LED Dimmer, CV, max. input current 10A, 12V-48V DC, SwitchDim2, remote ceiling & integration in luminaires

Art.Nr. 89453830: 2-channel LED Dimmer, CV, max. input current 16A, 12V-48V DC, SwitchDim2, remote ceiling & integration in luminaires

Art.Nr. 89453830-HS (16A DIN Rail):
2-channel LED Dimmer, CV, max. input current 16A, 12V-48V DC, SwitchDim2, DIN rail housing



Additional Information and Equipment

Lunatone DALI Cockpit

<https://www.lunatone.com/en/product/dali-cockpit/>

Lunatone datasheets and manuals

<https://www.lunatone.com/en/downloads-a-z/>

Lunatone DALI products

<https://www.lunatone.com/en/>

Contact

Technical Support: support@lunatone.com

Requests: sales@lunatone.com

www.lunatone.com

Disclaimer

Subject to change. Information provided without guarantee. The datasheet refers to the current delivery.

The compatibility with other devices must be tested in advance to the installation.