

DALI RGB LED Dimmer CV

Datasheet

Control Gear

DALI LED Dimmer (CV, DT8) for
RGB colour control



Art. Nr. 89453837 (4A)
Art. Nr. 86458514 (8A)
Art. Nr. 89453839 (10A)
Art. Nr. 89453842 (16A)

Art. Nr. 89453842-HS (16A DIN Rail)

DALI RGB LED Dimmer CV Control Gear

Overview

- DALI LED-Dimmer for RGB colour control
- suitable for constant voltage LED-modules with operating voltages from 12V to 48V
- **Operating Mode DT8:** one DALI-address for the independent control of light level and colour (DALI DT8, Type RGBWAF)
- **Operating Mode Colour&Dim:** control by 2 DALI-addresses, one for adjusting the light level and one for adjusting the colour
- **SwitchDim2:** 2 switch-inputs offer control of light level and colour without DALI
- dimming range 0.1%-100%
- adjustable PWM-frequency (122Hz/ 244Hz/ 488Hz/ 976Hz from FW version 4.6 on changed PWM frequencies: 250Hz / 500Hz / 1kHz)
- compact types for integration in luminaires, remote ceiling or DIN rail
- supply voltage 12V to 48V DC (according to the operating voltage of the led modules)
- type dependent max. input currents of 4A, 8A, 10A or 16A
- the maximum input current can be freely distributed between the channels.
- low standby power consumption
- high efficiency
- configuration via PC-software DALI-Cockpit and DALI USB-interface user
- user-friendly factory default settings

From FW Version 4.6 onward:

- DALI-2 compatible
- LED calibration for light adjustment
- Configurable RESET behaviour



Specification, Characteristics

type	DALI RGB LED Dimmer CV				
article number	89453837	86458514	89453839	89453842	89453842-HS
electrical data:					
supply voltage	12VDC-48VDC				
maximum input current I _{in_max}	4A	8A	10A	16A	
control input	DALI SwitchDim2 (mains voltage)				
current consumption DALI	2mA				
number of DALI-addresses	operating mode DT8: 1 operating mode Colour&Dim: 2				
standby power consumption (12V)	~ 120mW				

article number	89453837	86458514	89453839	89453842	89453842-HS
----------------	----------	----------	----------	----------	-------------

technical data:

power on behaviour	configurable: 0%-100% or last value		
storage/transportation temperature	-20°C ... +75°C		
ambient temperature	-20°C to +60°C		-20°C to +55°C
expected lifetime (at Tc<=75°C)	>100000h		
protection class	IP20		
max. connecting wire cross section	1.5 mm ²	2.5 mm ² / DALI & SwDim: 1.5 mm ²	2.5mm ²
dimensions (LxWxH)	59x33x15 mm	120x30x22 mm	98x18x56 mm
housing/mounting	back box	remote ceiling	DIN rail

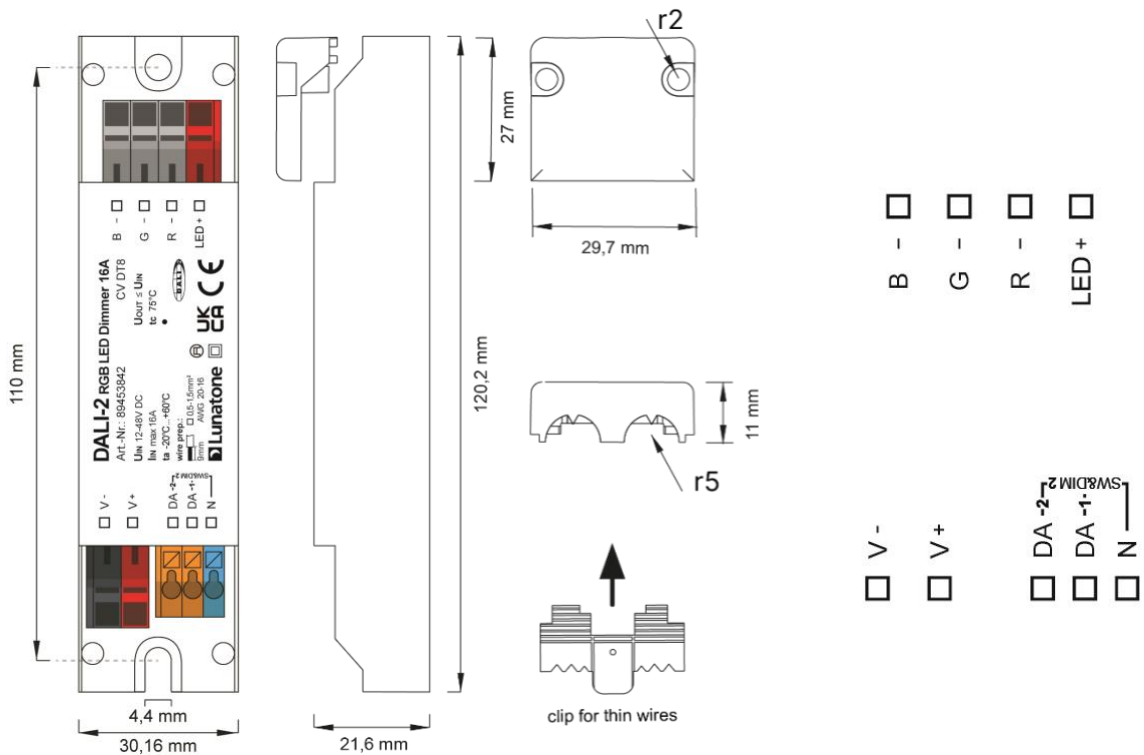

dimensions remote ceiling
Version 16A Art.Nr.: 89453842
Version 10A Art.Nr.: 89453839

connection plan remote ceiling
Version 16A Art.Nr.: 89453842
Version 10A Art.Nr.: 89453839

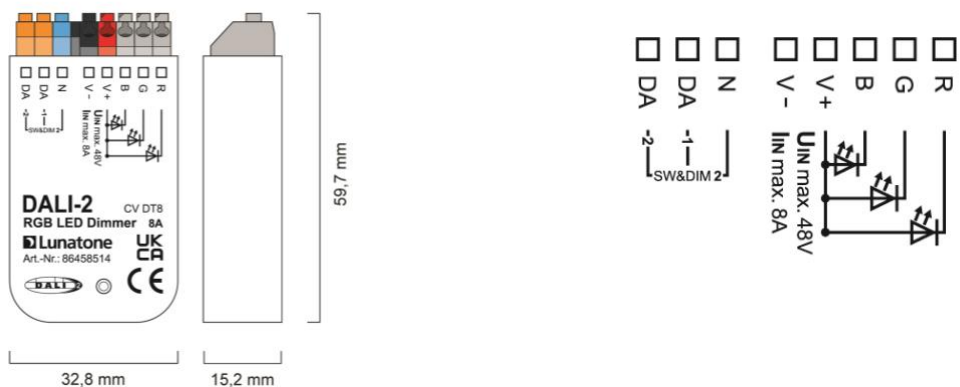

dimensions back box
Version 8A Art.Nr.: 86458514
Version 4A Art.Nr.: 89453837

connection plan back box
Version 8A Art.Nr.: 86458514
Version 4A Art.Nr.: 89453837

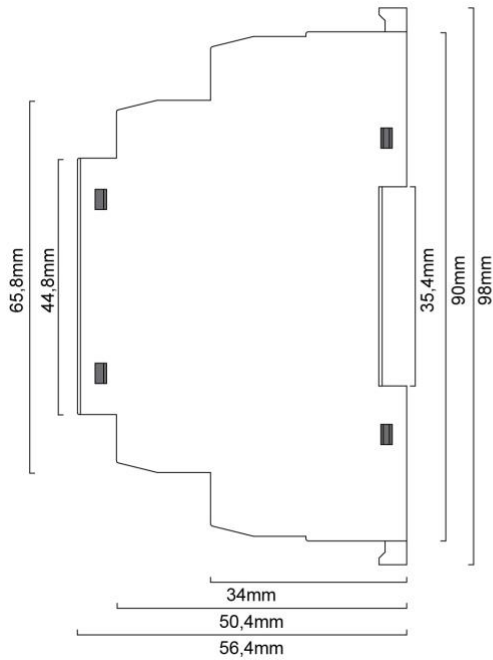

dimensions DIN rail
Version 16A Art.Nr.: 89453842-HS

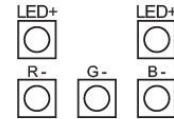
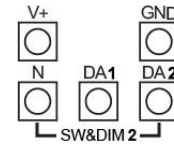
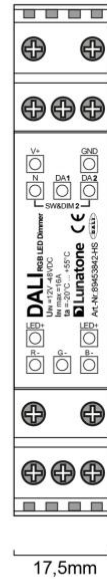

connection plan DIN rail
Version 16A Art.Nr.: 89453842-HS

RECOMMENDATION: Care should be taken on keeping cable lengths between DC power supply and dimmer, as well as between dimmer and luminaires (Led-Strings), as short as possible. This kind of installation will minimize the influence of voltage drops.

Control via DALI:

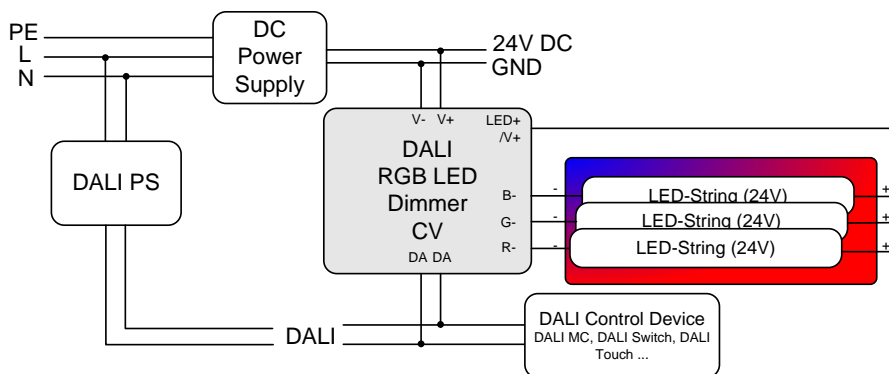

Control via SwitchDim2:

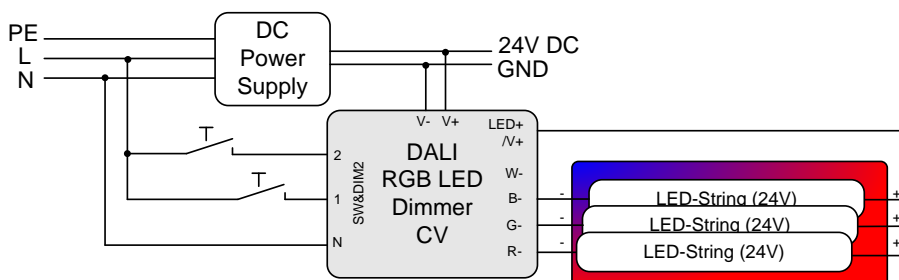

Operating Modes

The device offers two operating modes: DT8 and Colour&Dim.

DT8 (factory default)

In this operating mode one DALI-address for the independent control of light level and colour is used (Device Type 8 RGBWAF).

Alternatively, the device can be controlled using 2 switch-inputs for mains voltage (SwitchDim2):

SwD1: light level

short press: On/Off

long press: dimming

SwD2: colour

long press: change colour

Colour&Dim

This operating mode is suitable for operating RGB—luminaires. Two DALI-addresses are used, the first address to control the light level and the second address for changing the distribution on the output channels (e.g. for colour adjustments).

The Colour&Dim mode allows colour adjustments without affecting the level and vice versa. For each channel, DALI-standard commands like dim up/down and DAP are used. Thus, the device can be used with all common controls and gateways (e.g. KNX). The Colour&Dim mode provides an alternative to the DT8-RGBWAF mode.

Can be operated via DALI or SwitchDim2:

DALI-address 1, SwD1: light level

DALI-address 2, SwD2: colour

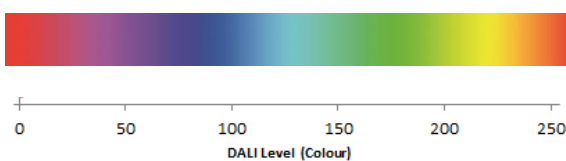

Selection of operating mode

With the help of the PC-software tool DALI-Cockpit the operating mode can be easily set on the general settings page.

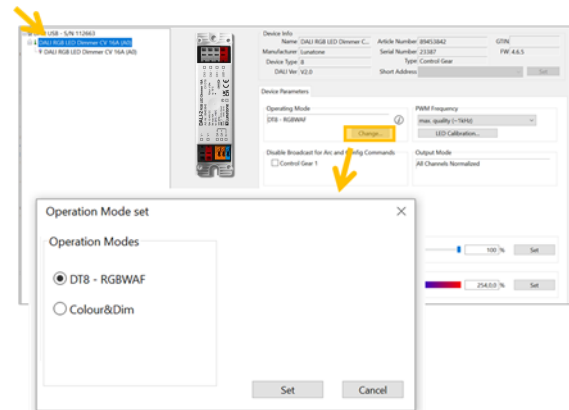

Operating modes can also be changed with the DALI-command SET OPERATING MODE (IEC 62386-102 Ed.2). When changing the operating mode, the number of used DALI-addresses might change as well, which requires a new addressing process. In the DALI-Cockpit this address assignment is performed automatically.

Operating Mode:

number	operating mode
0x0	DT8 (factory default)
0x92	DT8
0x93	Colour&Dim

Cockpit: General Settings

Component tree: selection of device overview



On the overview page, there are different control elements, depending on the operating mode (DT8 and Colour&Dim: a slider for light level and a slider for colour). Also, the following configuration options are available. (see also Figure 1.).

Overview: Operating mode DT8-RGBWAF

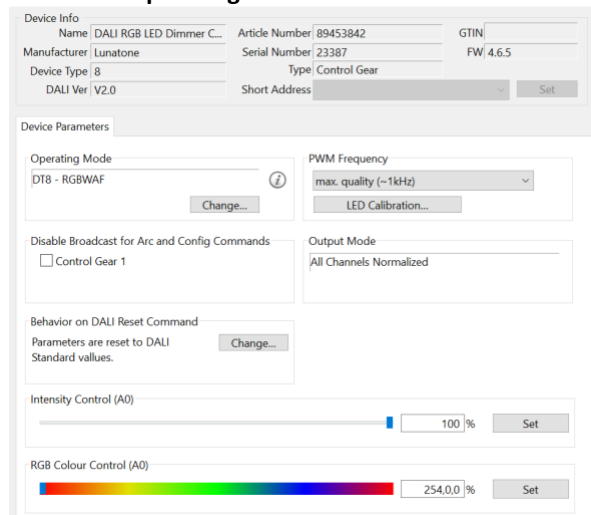

Overview: Operating mode Color&Dim

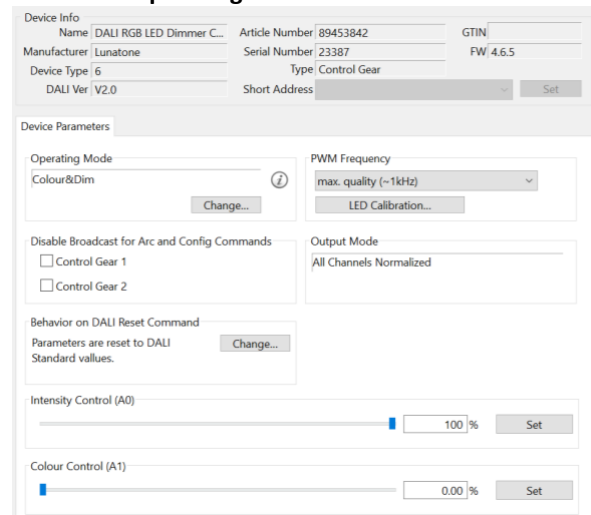

The **PWM frequency** can be selected:
 122Hz / 244Hz / 488Hz / 976Hz.
 From FW version 4.6 changed PWM frequencies: 250Hz / 500Hz / 1kHz.

The **broadcast control** can be deactivated for each channel individually.

Adjustable RESET behaviour: From FW version 4.6 up, the response to a DALI reset command is configurable. The following options are available:

- *Ignore command:* the DALI reset command does not trigger any changes to the device settings.
- *DALI standard:* the selected device settings are reset to the values defined in the DALI standard (see table 1 below - second column: DALI standard values)

Calibration - light adjustment: The dimming range extends from 0.1% to 100%. From FW version 4.6 on, it is possible to calibrate different light sources, with the option: LED calibration. For each channel, the MIN level (default: 0.1%) an intermediate value (default: 33%) and the MAX level (default: 100%) can be adjusted and matched between light sources.

To do this, set the desired level with the upper slider. Apply the value and start the fine adjustment by pressing the button next to it. The appropriate fine adjustments can now be made with the calibration slider below.

See Figure 1., page 7.

Cockpit: Additional Settings

Besides the settings on the general page each channel can be selected separately in the component tree for individual configuration.

Component Tree: selection of a channel

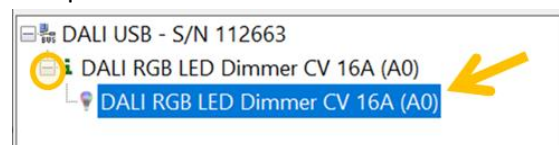

For each address the group membership, scene values and DALI-parameters can be set. In Colour&Dim operating mode, all values assigned to channel 2 are representing colours.

The settings for each operating mode are depicted below on page 8.

Device Info

Name	DALI RGB LED Dimmer C...	Article Number	89453842	GTIN	
Manufacturer	Lunatone	Serial Number	23387	FW	4.6.5
Device Type	8	Type	Control Gear		
DALI Ver	V2.0	Short Address			Set

Device Parameters

Operating Mode: DT8 - RGBWAF Change...

PWM Frequency: max. quality (~1kHz) LED Calibration...

Disable Broadcast for Arc and Config Commands: Control Gear 1

Output Mode: All Channels Normalized

Behavior on DALI Reset Command: Parameters are reset to DALI Standard values. Change...

Intensity Control (A0): 100 % Set

RGB Colour Control (A0): 254,0 % Set

LED Calibration

Channel 1 Channel 2 Channel 3

Min Level adjustment: MIN Level 0.100 %

33% Level adjustment (white balance): 33.333 %

Max Level adjustment: MAX Level 100 %

Behavior on DALI Reset Command

on DALI Reset command: DALI Standard

Valid for:

- Scene Levels
- DT8 Scene Colours
- MIN Level, MAX Level, Actual Level
- Fade Time / Fade Rate
- Groups
- PowerOnLevel, System Failure Level

Callout Boxes:

- When activated the device does not react to broadcast Arc (DAP) or configuration commands.
- Setting the light value to be calibrated
- Set the light value and start the adjustment.
- Fine adjustment of light value - direct feedback for comparison between lights

Figure 1 Cockpit overview page - General Settings

Factory Default Settings

Before the initial addressing is performed, the device can already be controlled by a group address. This predefined grouping will be deleted during the first addressing procedure. Afterwards groups can be assigned as usual (e.g. with the DALI Cockpit). By sending a DALI-Reset command the device is set to the DALI default values as defined in the standard.

The factory default values as well as the DALI-standard values are summarised in table 1 below.

Settings in the operating mode **DT8**

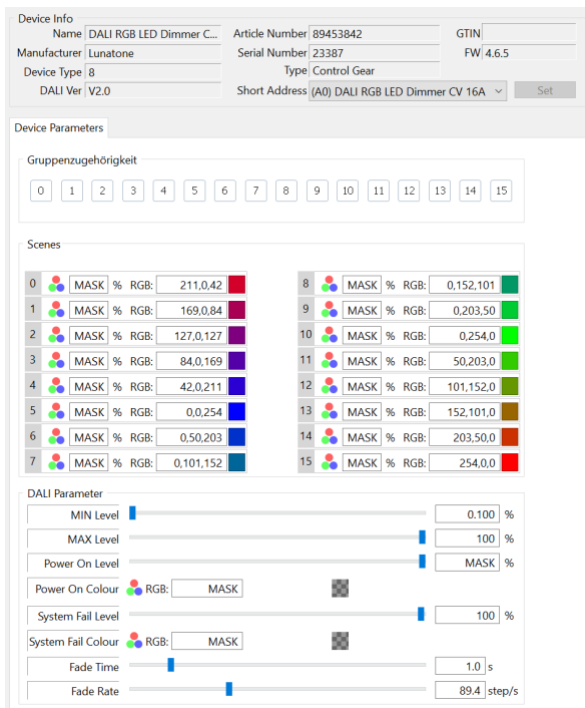

Settings for each channel in the operating mode **Colour&Dim**

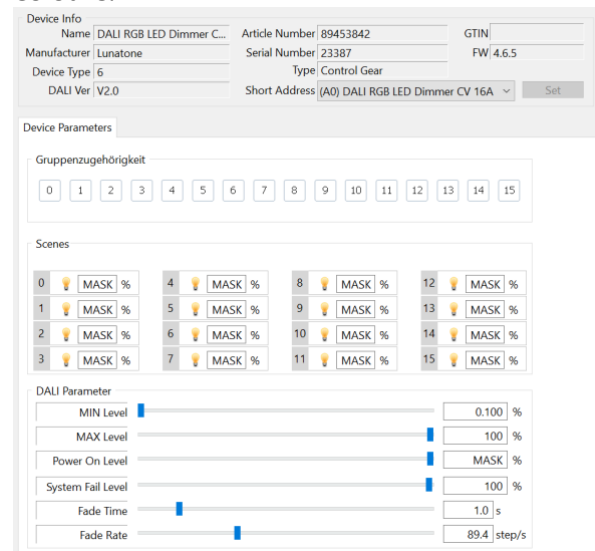

Summary of the factory default settings (delivery state):

	Factory default	DALI Standard																																
operating mode	DT8	---																																
switchDim2	SwD1: light level SwD2: colour	---																																
Min Level	0.1%	0.1%																																
Max Level	100%	100%																																
Power On Level	MASK (last value)	100%																																
System Failure Level	100%	100%																																
Fade Time	1s	None																																
Fade Rate	89.4 steps/s	44.7 steps/s																																
PWM-Frequency	122Hz or 1kHz for FW 4.6 and up	---																																
Groups before initial addressing	G0 (or G0 and G1 in operating mode Colour&Dim)	None																																
Scene values	<table border="1"> <tbody> <tr><td>0</td><td>MASK % RGB: 211,0,42</td><td>8</td><td>MASK % RGB: 0,152,101</td></tr> <tr><td>1</td><td>MASK % RGB: 169,0,84</td><td>9</td><td>MASK % RGB: 0,203,50</td></tr> <tr><td>2</td><td>MASK % RGB: 127,0,127</td><td>10</td><td>MASK % RGB: 0,254,0</td></tr> <tr><td>3</td><td>MASK % RGB: 84,0,169</td><td>11</td><td>MASK % RGB: 50,203,0</td></tr> <tr><td>4</td><td>MASK % RGB: 42,0,211</td><td>12</td><td>MASK % RGB: 101,152,0</td></tr> <tr><td>5</td><td>MASK % RGB: 0,0,254</td><td>13</td><td>MASK % RGB: 152,101,0</td></tr> <tr><td>6</td><td>MASK % RGB: 0,50,203</td><td>14</td><td>MASK % RGB: 203,50,0</td></tr> <tr><td>7</td><td>MASK % RGB: 0,101,152</td><td>15</td><td>MASK % RGB: 254,0,0</td></tr> </tbody> </table>	0	MASK % RGB: 211,0,42	8	MASK % RGB: 0,152,101	1	MASK % RGB: 169,0,84	9	MASK % RGB: 0,203,50	2	MASK % RGB: 127,0,127	10	MASK % RGB: 0,254,0	3	MASK % RGB: 84,0,169	11	MASK % RGB: 50,203,0	4	MASK % RGB: 42,0,211	12	MASK % RGB: 101,152,0	5	MASK % RGB: 0,0,254	13	MASK % RGB: 152,101,0	6	MASK % RGB: 0,50,203	14	MASK % RGB: 203,50,0	7	MASK % RGB: 0,101,152	15	MASK % RGB: 254,0,0	all scenes: MASK (brightness: MASK and colour: MASK)
0	MASK % RGB: 211,0,42	8	MASK % RGB: 0,152,101																															
1	MASK % RGB: 169,0,84	9	MASK % RGB: 0,203,50																															
2	MASK % RGB: 127,0,127	10	MASK % RGB: 0,254,0																															
3	MASK % RGB: 84,0,169	11	MASK % RGB: 50,203,0																															
4	MASK % RGB: 42,0,211	12	MASK % RGB: 101,152,0																															
5	MASK % RGB: 0,0,254	13	MASK % RGB: 152,101,0																															
6	MASK % RGB: 0,50,203	14	MASK % RGB: 203,50,0																															
7	MASK % RGB: 0,101,152	15	MASK % RGB: 254,0,0																															
Behaviour at DALI RESET command	set DALI Standard values, see column 2	---																																

Table 1 factory default settings column 1, DALI Standard settings column 2

Purchase Order Information

Art.Nr. 89453837: RGB LED Dimmer, CV, input current 4A, 12V-48V DC, SwitchDim2, back box

Art.Nr. 86458514: RGB LED Dimmer, CV, input current 8A, 12V-48V DC, SwitchDim2, back box

Art.Nr. 89453839: RGB LED Dimmer, CV, input current 10A, 12V-48V DC, SwitchDim2, remote ceiling & integration in luminaires

Art.Nr. 89453842: RGB LED Dimmer, CV, input current 16A, 12V-48V DC, SwitchDim2, remote ceiling & integration in luminaires

Art.Nr. 89453842-HS (16A DIN Rail): RGB LED Dimmer, CV, input current 16A, 12V-48V DC, SwitchDim2, DIN rail housing

Additional Information and Equipment

Lunatone DALI Cockpit

<https://www.lunatone.com/en/product/dali-cockpit/>

Lunatone datasheets and manuals

<https://www.lunatone.com/en/downloads-a-z/>

Lunatone DALI products

<https://www.lunatone.com/en/>

Contact

Technical Support: support@lunatone.com

Requests: sales@lunatone.com

www.lunatone.com



Disclaimer

Subject to change. Information provided without guarantee.
The datasheet refers to the current delivery.

The compatibility with other devices must be tested in advance to the installation.