

ULTRA-LONG LED FLEX LINEAR



Solvents
Resistant



Saltwater
Resistant



UV
Resistant



IP67
Protection



IK10
Protection



5 years
Warranty

Ultra-Long Flexible Light Series are available in F2010 and F2219. With a single power feed, these uninterrupted lights can run up to 200 meters. These extended lights can produce consistent brightness at both ends. The lights are made of silicone and can be widely applied outdoors, such as high-rise buildings, bridges and tunnels.

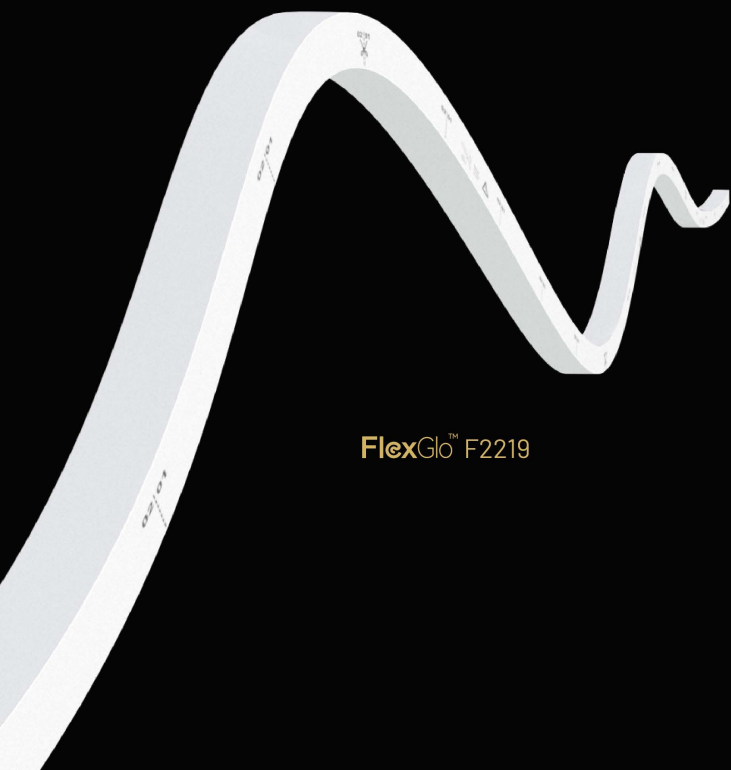

FlexGlo™ F2219

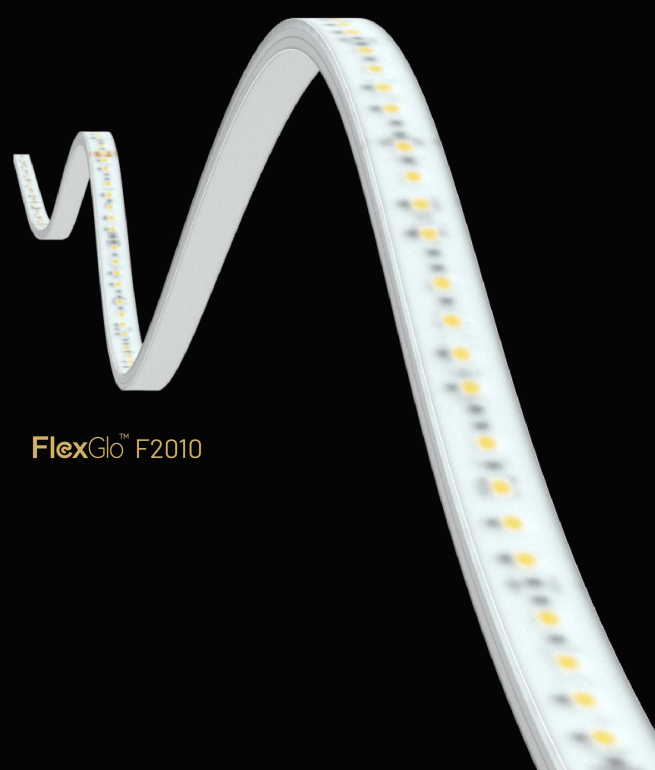

FlexGlo™ F2010



[•]
Consistent Brightness
from End to End

[•]
Lowered Maintenance Costs
with Less Power Supplies &
Cables

[•]
Safe Voltage DC 48V

[•]
Excellent Heat Sink



PRODUCT NOMENCLATURE

C-SFR-F2219B-VB-48CC-27K-WM-80-6W-125

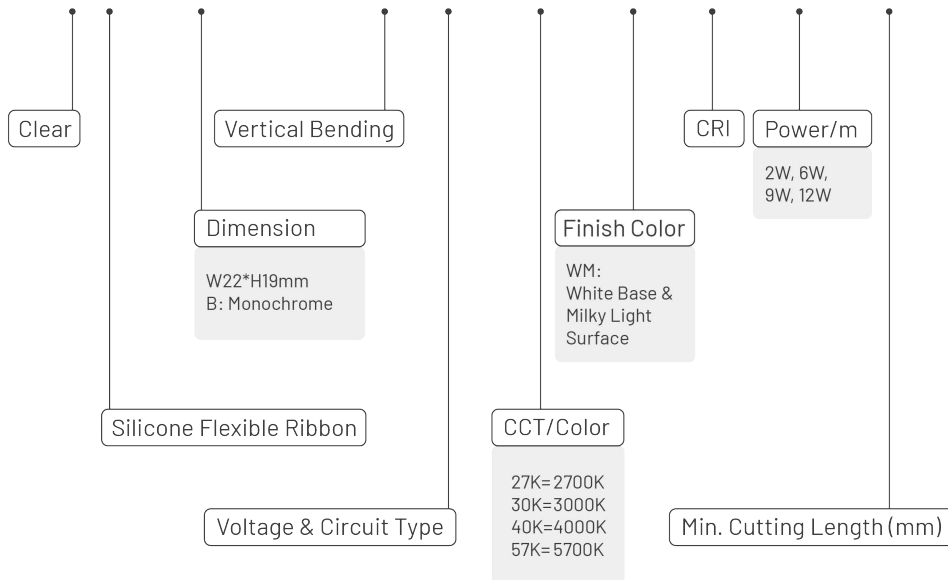

SPECIFICATION

PARAMETER

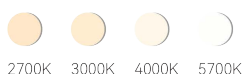

Ambient Working Temperature
-40~55°C / -40~131°F

Storage Temperature
-40 ~ 60°C / -40~140°F

Ambient Installation Temperature
> -40°C / -40°F

Max. Mounting Surface Temperature
85°C / 185°F

Item No.	F2219
Voltage	DC48V
Rated Power/m	2W, 6W, 9W, 12W
IP Rating	IP67
CRI	>80
Weight/m	522g

DIMENSION

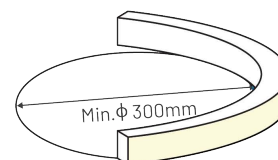
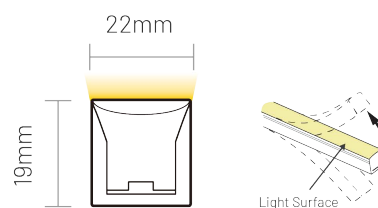

STANDARD LENGTH

Min. Cutting Length: 125mm
 Max. Run Length:
 200m (20m*10pcs) @2W/m,
 140m (20m*7pcs) @6W/m,
 120m (20m*6pcs) @9W/m,
 100m (20m*5pcs) @12W/m

PHOTOMETRIC CURVE

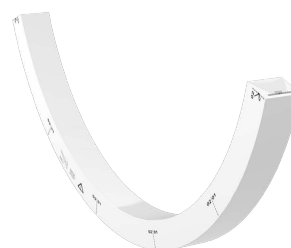
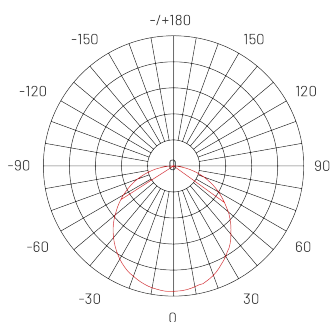

E.g.: C-SFR-F2219B-VB-48CC-30K-WM-80-12W-125
AVERAGE BEAM ANGLE(50%):111.7°

Item Code	Finished Product					
	CCT	CCT Tolerance	Color Tolerance	CRI	Lumen/m	Lumen/ft
C-SFR-F2219B-VB-48CC-27K-WM-80-2W-125	2700K	2725±115K	<5SDCM	80	>120	>37
C-SFR-F2219B-VB-48CC-30K-WM-80-2W-125	3000K	3045±140K	<5SDCM	80	>130	>40
C-SFR-F2219B-VB-48CC-40K-WM-80-2W-125	4000K	3985±225K	<5SDCM	80	>140	>43
C-SFR-F2219B-VB-48CC-57K-WM-80-2W-125	5700K	5665±355K	<5SDCM	80	>140	>43
C-SFR-F2219B-VB-48CC-27K-WM-80-6W-125	2700K	2725±115K	<5SDCM	80	>340	>104
C-SFR-F2219B-VB-48CC-30K-WM-80-6W-125	3000K	3045±140K	<5SDCM	80	>360	>110
C-SFR-F2219B-VB-48CC-40K-WM-80-6W-125	4000K	3985±225K	<5SDCM	80	>360	>110
C-SFR-F2219B-VB-48CC-57K-WM-80-6W-125	5700K	5665±355K	<5SDCM	80	>360	>110
C-SFR-F2219B-VB-48CC-27K-WM-80-9W-125	2700K	2725±115K	<5SDCM	80	>520	>159
C-SFR-F2219B-VB-48CC-30K-WM-80-9W-125	3000K	3045±140K	<5SDCM	80	>540	>165
C-SFR-F2219B-VB-48CC-40K-WM-80-9W-125	4000K	3985±225K	<5SDCM	80	>550	>168
C-SFR-F2219B-VB-48CC-57K-WM-80-9W-125	5700K	5665±355K	<5SDCM	80	>550	>168
C-SFR-F2219B-VB-48CC-27K-WM-80-12W-125	2700K	2725±115K	<5SDCM	80	>700	>213
C-SFR-F2219B-VB-48CC-30K-WM-80-12W-125	3000K	3045±140K	<5SDCM	80	>720	>220
C-SFR-F2219B-VB-48CC-40K-WM-80-12W-125	4000K	3985±225K	<5SDCM	80	>740	>226
C-SFR-F2219B-VB-48CC-57K-WM-80-12W-125	5700K	5665±355K	<5SDCM	80	>740	>226

CONNECTOR



IP67 Silicone Injection-moulded
Front Connector-End

F2219B-VB-SIM/FC-01/02-E

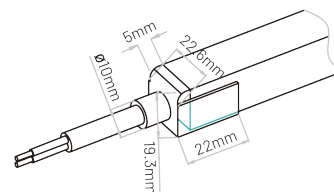

IP67 Silicone Injection-moulded
End Cap

F2219-SIM/EC

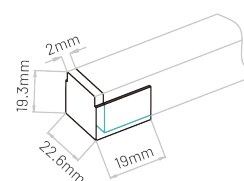

Male & Female Connector

Optional
For plug and play cable junction, IP67

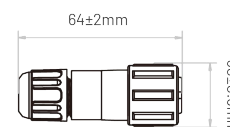

PROFILE



F2219 Serrated Aluminum Profile

F2219-SA/PL
Standard Length
20mm, 500mm, 1000mm, 2000mm

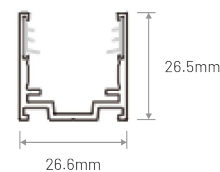

F2219 Flange Serrated Aluminum Profile

F2219-FSA/PL
Standard Length
20mm, 500mm, 1000mm, 2000mm

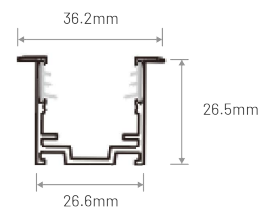

PRODUCT NOMENCLATURE

C-SFR-F2010B-VB-48CC-27K-WT-80-9W-250

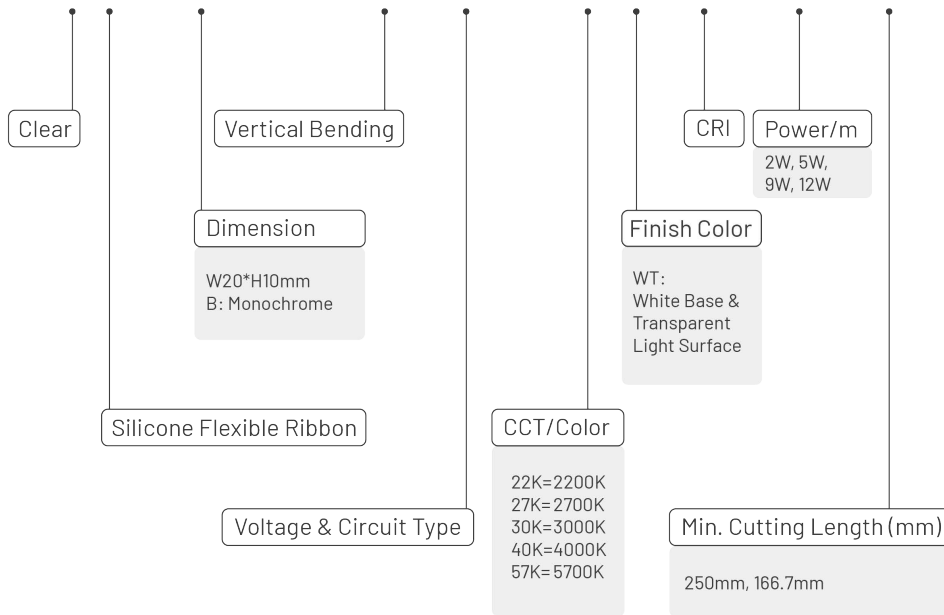

SPECIFICATION

PARAMETER



Ambient Working Temperature
-40~55°C / -40~131°F

Storage Temperature
-40 ~ 60°C / -40~140°F

Ambient Installation Temperature
> -40°C / -40°F

Max. Mounting Surface Temperature
85°C / 185°F

Item No.	F2010
Voltage	DC48V
Rated Power/m	2W, 5W, 9W, 12W
IP Rating	IP67
CRI	>80
Weight/m	285g

DIMENSION

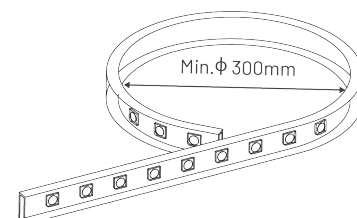

STANDARD LENGTH

Min. Cutting Length:
250mm (2W, 5W, 9W), 166.7mm (12W)
Max. Run Length:
200m (20m*10pcs) @2W/m,
180m (20m*9pcs) @5W/m,
120m (20m*6pcs) @9W/m,
100m (20m*5pcs) @12W/m

PHOTOMETRIC CURVE

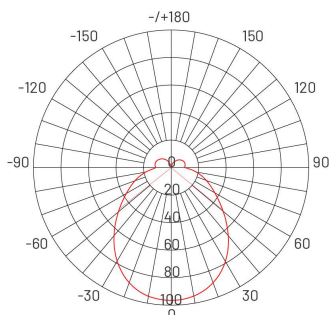

E.g.: C-SFR-F2010B-VB-48CC-30K-WT-80-2W-250
 AVERAGE BEAM ANGLE(50%):102.1°

Item Code	Finished Product					
	CCT	CCT Tolerance	Color Tolerance	CRI	Lumen/m	Lumen/ft
C-SFR-F2010B-VB-48CC-22K-WT-80-2W-250	2200K	2238±82K	<5SDCM	80	>170	>52
C-SFR-F2010B-VB-48CC-27K-WT-80-2W-250	2700K	2725±115K	<5SDCM	80	>170	>52
C-SFR-F2010B-VB-48CC-30K-WT-80-2W-250	3000K	3045±140K	<5SDCM	80	>170	>52
C-SFR-F2010B-VB-48CC-35K-WT-80-2W-250	3500K	3465±170K	<5SDCM	80	>180	>55
C-SFR-F2010B-VB-48CC-40K-WT-80-2W-250	4000K	3985±225K	<5SDCM	80	>180	>55
C-SFR-F2010B-VB-48CC-57K-WT-80-2W-250	5700K	5665±355K	<5SDCM	80	>180	>55
C-SFR-F2010B-VB-48CC-22K-WT-80-5W-250	2200K	2238±82K	<5SDCM	80	>400	>122
C-SFR-F2010B-VB-48CC-27K-WT-80-5W-250	2700K	2725±115K	<5SDCM	80	>400	>122
C-SFR-F2010B-VB-48CC-30K-WT-80-5W-250	3000K	3045±140K	<5SDCM	80	>400	>122
C-SFR-F2010B-VB-48CC-35K-WT-80-5W-250	3500K	3465±170K	<5SDCM	80	>420	>128
C-SFR-F2010B-VB-48CC-40K-WT-80-5W-250	4000K	3985±225K	<5SDCM	80	>420	>128
C-SFR-F2010B-VB-48CC-57K-WT-80-5W-250	5700K	5665±355K	<5SDCM	80	>420	>128
C-SFR-F2010B-VB-48CC-22K-WT-80-9W-250	2200K	2238±82K	<5SDCM	80	>670	>204
C-SFR-F2010B-VB-48CC-27K-WT-80-9W-250	2700K	2725±115K	<5SDCM	80	>670	>204
C-SFR-F2010B-VB-48CC-30K-WT-80-9W-250	3000K	3045±140K	<5SDCM	80	>670	>204
C-SFR-F2010B-VB-48CC-35K-WT-80-9W-250	3500K	3465±170K	<5SDCM	80	>700	>213
C-SFR-F2010B-VB-48CC-40K-WT-80-9W-250	4000K	3985±225K	<5SDCM	80	>700	>213
C-SFR-F2010B-VB-48CC-57K-WT-80-9W-250	5700K	5665±355K	<5SDCM	80	>700	>213
C-SFR-F2010B-VB-48CC-22K-WT-80-12W-166.7	2200K	2238±82K	<5SDCM	80	>910	>277
C-SFR-F2010B-VB-48CC-27K-WT-80-12W-166.7	2700K	2725±115K	<5SDCM	80	>910	>277
C-SFR-F2010B-VB-48CC-30K-WT-80-12W-166.7	3000K	3045±140K	<5SDCM	80	>910	>277
C-SFR-F2010B-VB-48CC-35K-WT-80-12W-166.7	3500K	3465±170K	<5SDCM	80	>950	>290
C-SFR-F2010B-VB-48CC-40K-WT-80-12W-166.7	4000K	3985±225K	<5SDCM	80	>950	>290
C-SFR-F2010B-VB-48CC-57K-WT-80-12W-166.7	5700K	5665±355K	<5SDCM	80	>950	>290

CONNECTOR



IP67 Silicone Injection-moulded Front Connector-End

F2010B-VB-SIM/FC-01/02-E

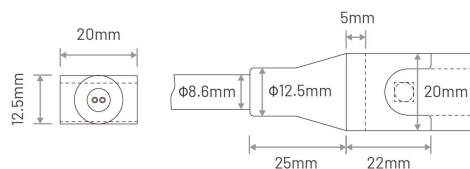

IP67 Silicone Injection-moulded End Cap

F2010-SIM/EC

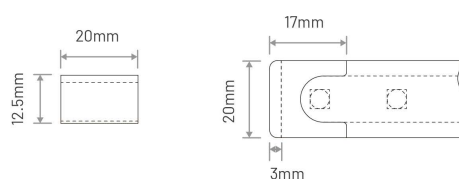

Male & Female Connector

Optional
For plug and play cable junction, IP67

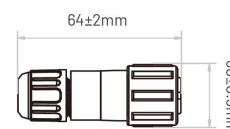

PROFILE



F2010 Suspension Kit

F2010-S/KT

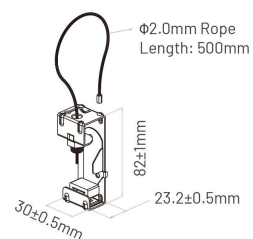

F2010 Stainless Steel Profile

F2010-S/PL-500MM-SSL

Standard Length: 500mm

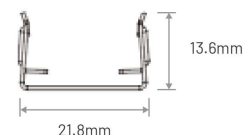

INSTALLTION INSTRUCTIONS F2010 Suspension Kit

Friendly Reminder: please read instructions carefully before operation.

▶ Step 1

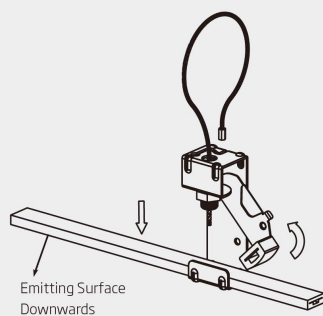

Rotate the safety lock outwards and put the LED strip in the J hook.

▶ Step 2

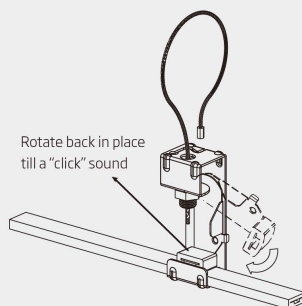

Rotate the safety lock back to press the led strip tightly.

▶ Step 3

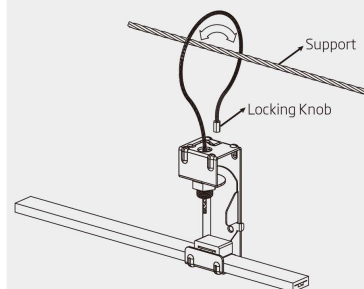

Wind the wire rope with the locking knob around the support.

▶ Step 4

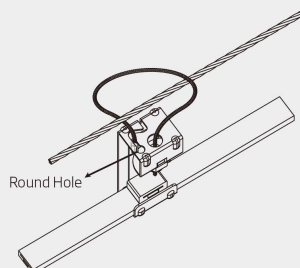

Thread the locking knob of wire rope through the round hole.

▶ Step 5

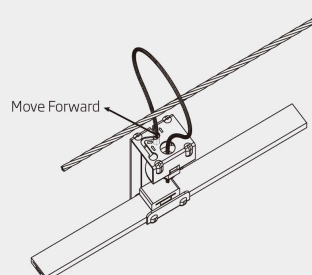

Move the wire rope forward to the end along with the arrows aside.

▶ Step 6

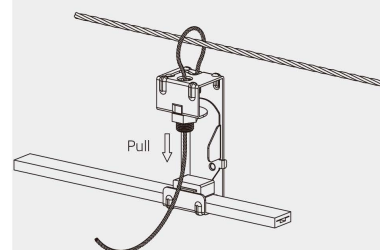

Pull the wire rope to adjust the height to the desired one.

▶ Step 7

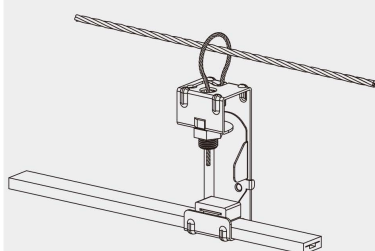

Cut or roll the excess wire rope.

NOTE: The recommended quantity is 3pcs for every meter or adjustable based on the specific case.

▶ Tip

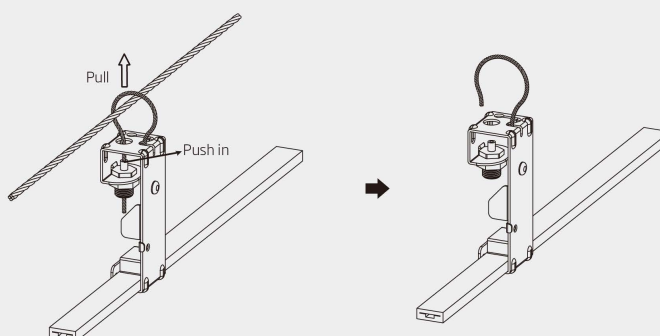

Push in the plunger of cable gripper to pull out the wire rope if needed.

INSTALLATION INSTRUCTIONS F2010 Stainless Steel Profile

Friendly Reminder: please read instructions carefully before operation.

Components



Stainless Steel Mounting Profile



Stainless Steel Strap
(silicone anti-skidding sleeve included)



Joining Bracket



Clip
(silicone protective sleeve included)



Screw

Step 1

Profile Joining

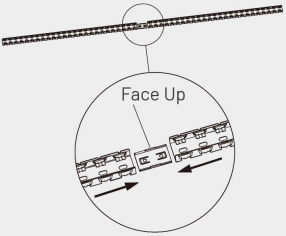

Connect at most 3 pieces

Suitable for Both Installation Ways

INSTALLATION WAY-1

Screw Mounting

Step 2



Wall

Mark the mounting positions and tighten screws.

Step 3

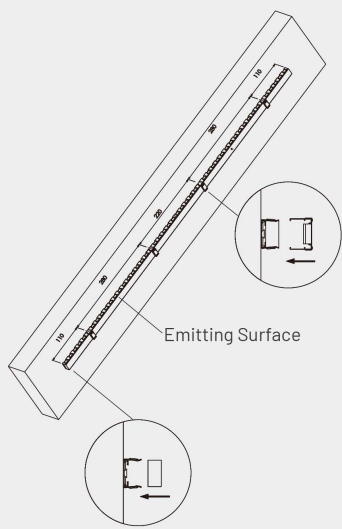

Emitting Surface

Put the light in and fix by the clip.

INSTALLATION WAY-2

Strap Mounting

Step 2

Tube or bar that allow to bind to

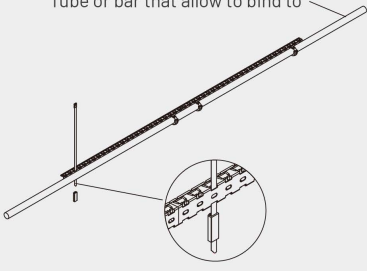

Thread the strap through the mounting profile and then cover it with silicone anti-skidding sleeve. Be attention to the direction when strapping.

Step 3

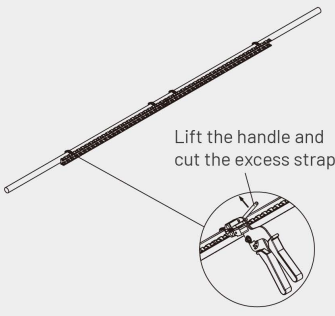

Lift the handle and cut the excess strap.

Insert the strap into the strap wrench. Then press the wrench tightly and take care the damage to the profile.

Step 4

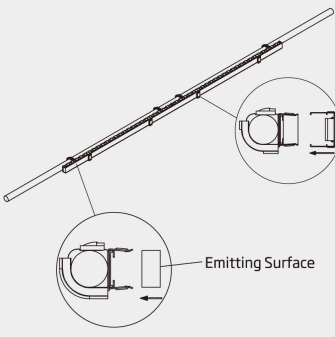

Emitting Surface

Put the light in and fix by the clip.