



 **Lunatone**

INTERFACES, TOOLS & GATEWAYS



Folder E



INTERFACES, TOOLS & GATEWAYS

The devices in the following chapter enable communication with the DALI bus via a range of interfaces:

- DALI-2 USB, DALI-2 WLAN - communication between DALI Cockpit PC software and DALI bus
- DALI Cockpit - PC software
- DALI 4Net - control of 4 DALI lines
- DALI SCI RS232 interface
- IoT Gateway - interface for smart home solutions
- KNX Gateway

- Bluetooth interfaces including apps for iOS and Android
- Audio interface
- Interface for connecting conventional motion sensors or switches
- Converter between DALI DT8 and DT6
- DALI to DSI converter
- Converter from 0-10V to DALI and 4-20mA to DALI
- 0-10V interfaces with 8A or 16A relays
- Control of 230V AC blind motors
- Implementation of DALI to 0-10V or 1-10V or PWM

TABLE OF CONTENTS

Folder E

DALI Cockpit - PC software	2	DALI-2 Audio Interface	13
a short introduction on commission a DALI system	2	DALI SI, SI-1L	14
DALI-2 USB 30mA	4	DALI DSI - converting DALI to DSI	14
DALI USB	4	DALI Dim2warm - converting DT6 commands to 2x DT6	15
DALI Flash USB	5	DALI DT8 to DT6 - converting DT8-Tc commands to 2x DT6	15
DALI-2 WLAN Cockpit Interface	5	0-10V DALI - converting 0-10V to DALI with 10mA bus supply	16
DALI 4Net - control of 4 DALI lines	6	0-10V DALI - converting 0-10V to DALI with 1, 2 or 3 channels	17
DALI-2 SCI RS232	7	0-10V DALI - converting 0-10V to DALI with 30mA bus supply	17
DALI-2 RS232 PS - integrated DALI bus power supply	7	4-20mA to DALI Converter - 24V, with 30mA bus supply	18
DALI-2 IoT Gateway	8	4-20mA to DALI Converter - 230V, with 30mA bus supply	18
KNX DALI-2 Gateway	9	DALI RM8 / RM16 0-10V - relay module with 0-10V input	19
KNX 4 DALI Gateway	10	DALI RM8 / RM16 2x0-10V - for 2 devices with 0-10V input	19
DALI-2 KNX Room Controller	10	wDALI RM8 0/1-10V PWM - wireless relay module with 0/1-10V	20
DALI-2 Room Controller	11	DALI Jalousie - 230VAC	20
DALI Cockpit Mobile - Smartphone application	12	DALI 0/1-10V - converting DALI to 0-10V, 1-10V or PWM	21
DALI Daylight Bluetooth Interface	13	Overview folder A-E	22

DALI Cockpit - PC software

DALI Cockpit is a user-friendly PC software for commissioning, addressing, and configuring DALI systems.

The software is currently available for free and can be downloaded at www.lunatone.com. The following functions are supported: addressing DALI devices, configuring Lunatone DALI components, configuring standard DALI operating devices,

defining groups and scenes, sending DALI commands, creating macros, as well as saving and loading an entire DALI system configuration.

The software package also includes a DALI monitor, which allows observation, control and recording of DALI bus communication.

a short introduction on how to commission a DALI system with the DALI Cockpit software

The configuration of a DALI lighting control system requires some planning and careful execution to ensure lighting requirements are met and the system performs reliably. The DALI Cockpit software supports you in this task. The system configuration generally goes as follows:



1 Installing the software

- Lunatone software can be downloaded at: <https://www.lunatone.com/en/product/dali-cockpit/>
- The software package consists of 3 parts: DALI Cockpit, DALI Monitor and DALI Bus Server
- Supported operating system: Windows (Windows 7 and higher)

2 Establish hardware connection

- Make sure the DALI system is wired correctly
- The DALI lighting system can be connected to a PC via one of these interface modules:
DALI USB, DALI-2 WLAN, DALI 4Net, DALI SCI RS232, DALI-2 Display, DALI-2 IoT, ...

3 Addressing the DALI system

- Open the PC software DALI Cockpit and select the interface device, when the interface page opens, click on "Addressing":
→ for existing installations and systems that have already been addressed select: "System Extension"
→ for new systems select: "Complete new installation"
- The software automatically searches for DALI devices on the network and lists them.

4 Device configuration

- All addressed devices are listed on the left side of the program window in the "device tree"
→ the corresponding device configuration page can be opened by clicking on a device.
- Configure the settings for each device according to your requirements.

5 System configuration

- With DALI groups, multiple DALI devices can be combined. DALI groups enable the collective control of different areas in a room or building.
- Scenes can be set up to establish predefined lighting scenarios, for example, for different times of the day or activities.
- Macros can be used to create a list of commands and combine them into a package. Macros enable an easy recall of complex functions.

6 Testing and monitoring

- Test your configuration to ensure the system works as planned.
- Monitoring bus traffic and bus diagnostics are possible with the PC software: "DALI Monitor".

add. 4 Device configuration

The programming of the various control devices such as DALI Touchpanel, DALI Switch Cross, DALI Remote control, DALI MC

and DALI MC4L is very similar. Below is an example of the DALI Switch Cross:

The screenshot shows the configuration interface for a DALI Switch. It includes fields for Device Info (Name: DALI Switch, Manufacturer: Lunatone, Article Number: 86459793, Serial Number: N/A, DALI Device Type: N/A, Short Address: eA1) and Settings for Button 1. The Destination Address section has four dropdowns (1-4) all set to 'none'. The Function is set to 'BF6 Dim button: CmdX/CmdY/UP/DOWN depending on actual light level'. Cmd X (ON Cmd) is 'RECALL MAX' and Cmd Y (OFF Cmd) is 'OFF'. A 'Power up Action after power up:' dropdown is set to 'no change' and a 'Delay:' field is set to '0 | [0...7sec]'. Callouts point to: 1. The button selection icon; 2. The Destination Address dropdowns; 3. The Function dropdown; 4. The Cmd X and Cmd Y dropdowns.

add. 5 System configuration: Scene configurator

The screenshot shows the 'Scenes configuration' window. It includes a 'Destination Address' dropdown set to 'All (DALI Broadcast)'. Under 'Scene type', 'DT8 RGBWAF' is selected. A 'Scene set' grid shows 15 numbered color swatches. 'Scene Settings' for 'Scene 7' includes sliders for Act, R, G, B, W, A, and F, with corresponding percentage values (e.g., R: 2.76%, G: 75.98%, B: 11.42%). An 'RGB Colour Selection' dialog is open, showing a color picker with 'R=7, G=193, B=29'. Callouts explain: 1. Scene types (Level only, DT8 RGBWAF, DT8 Tc, DT8 XY); 2. Scene set grid; 3. Scene Settings sliders; 4. RGB Colour Selection dialog; 5. 'Store all' button; 6. 'effective range of the scene: entire DALI bus (broadcast), a group or address'; 7. 'a double-click on the colour field opens the RGB colour picker'; 8. 'save the configuration, as displayed in the preview, for all scene numbers'.

DALI-2 USB 30mA

The DALI-2 USB is used as interface between the PC software DALI Cockpit and the devices on the DALI bus. It enables the addressing and configuration of DALI installations.

The interface documentation is available: LUBA protocol, an intelligent protocol for easy access to the DALI system. The device has an integrated switchable 30mA bus power supply. Due to its compact size, the device is suitable for installation in flush-type installation boxes.



NAME	ARTICLE NUMBER	TYP. DALI CURRENT CONSUMPTION	USB CABLE IN SCOPE OF DELIVERY	TYP. USB CURRENT CONSUMPTION	INTEGRATED DALI POWER SUPPLY	MODEL	DIMENSIONS (MM)
DALI-2 USB 30mA	24138215-30	-	USB C (on device) to USB C	40mA	30mA	for flush-type installation boxes	59 x 33 x 15

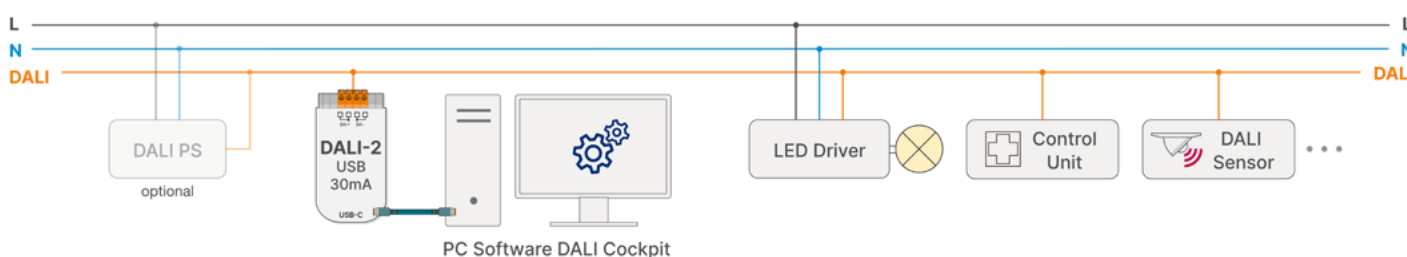

DALI USB

The DALI USB is used as interface between the PC software DALI Cockpit and the devices on the DALI bus. It enables the addressing and configuration of DALI installations.

DALI USB is available in 6 different versions: with strain relief, for DIN rail (with or without flash memory), for flush-type installation boxes (with or without integrated switchable 30mA bus power supply), or as a wireless wDALI module.



NAME	ARTICLE NUMBER	TYP. DALI CURRENT CONSUMPTION	USB CABLE IN SCOPE OF DELIVERY	TYP. USB CURRENT CONSUMPTION	WIRELESS	INTEGRATED DALI POWER SUPPLY	MODEL	DIMENSIONS (MM)
DALI USB DIN rail	24138923-HS	6mA	USB Mini (on device) to USB A	10mA	-	-	for DIN rail	98 x 17,5 x 57
DALI USB Flash	89454248	6mA	USB Mini (on device) to USB A	10mA	-	-	for DIN rail	98 x 17,5 x 57
DALI USB	24138923	6mA	USB B (on device) to USB A	10mA	-	-	with strain relief for suspended ceilings	102 x 51 x 30
DALI USB MINI	24138923DO	6mA	USB Mini (on device) to USB A	10mA	-	-	for flush-type installation boxes	59 x 33 x 15
DALI USB 30mA	24138923-30	-	USB Mini (on device) to USB A	40mA	-	30mA	for flush-type installation boxes	59 x 33 x 15
DALI-2 USB 30mA	24138215-30	-	USB C (on device) to USB C	40mA	-	30mA	for flush-type installation boxes	59 x 33 x 15
wDALI USB	24138923-WD	9mA	USB Dongle	40mA	2.4Ghz up to 50m	-	for flush-type installation boxes	59 x 33 x 15

DALI Flash USB

The DALI Flash USB enables the communication between the DALI Cockpit PC software and devices on the DALI bus. Compared to other DALI USB versions, this device has a flash memory to store the bus configuration and all device settings. This allows the file to be kept locally and prevents loss of information. The DALI Flash USB is suitable for DIN rail mounting.



NAME	ARTICLE NUMBER	TYP. DALI CURRENT CONSUMPTION	USB CABLE SCOPE OF DELIVERY	TYP. USB CURRENT CONSUMPTION	MODEL	DIMENSIONS (MM)
DALI USB Flash	89454248	6mA	USB Mini (on device) to USB A	10mA	for DIN rail	98 x 17,5 x 57

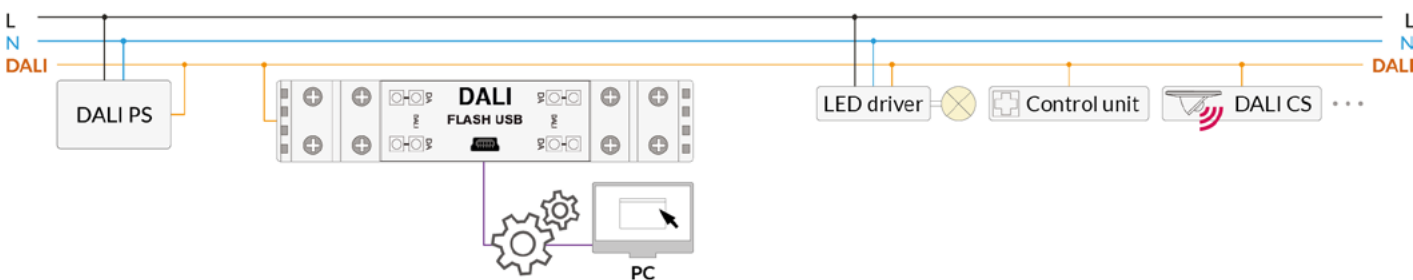

DALI-2 WLAN Cockpit Interface

WLAN – DALI Interface module for commissioning, configuration and control of a DALI system via WIFI, using the PC software DALI Cockpit. The DALI-2 WLAN module is ready for operation immediately after connection. The interface can be used via the device's hotspot or added to a local network. Supported from DALI Cockpit version 1.38 onwards. The device version DALI-2 WLAN PS (item no. 24138478-PS) has an integrated DALI bus power supply and delivers 200mA for up to 64 standard DALI operating devices.



NAME	ARTICLE NUMBER	INPUT VOLTAGE	INTEGRATED DALI POWER SUPPLY	INTERFACE	OPERATING TEMPERATURE (TA)	MODEL	DIMENSIONS (MM)
DALI-2 WLAN Cockpit Interface	24138478	100-240V AC	-	WLAN-DALI	-20°C ... +60°C	with strain relief for suspended ceilings	120 × 41 × 22
DALI-2 WLAN PS Cockpit Interface	24138478-PS	100-240V AC	240mA	WLAN-DALI	-20°C ... +60°C	with strain relief for suspended ceilings	120 × 41 × 22

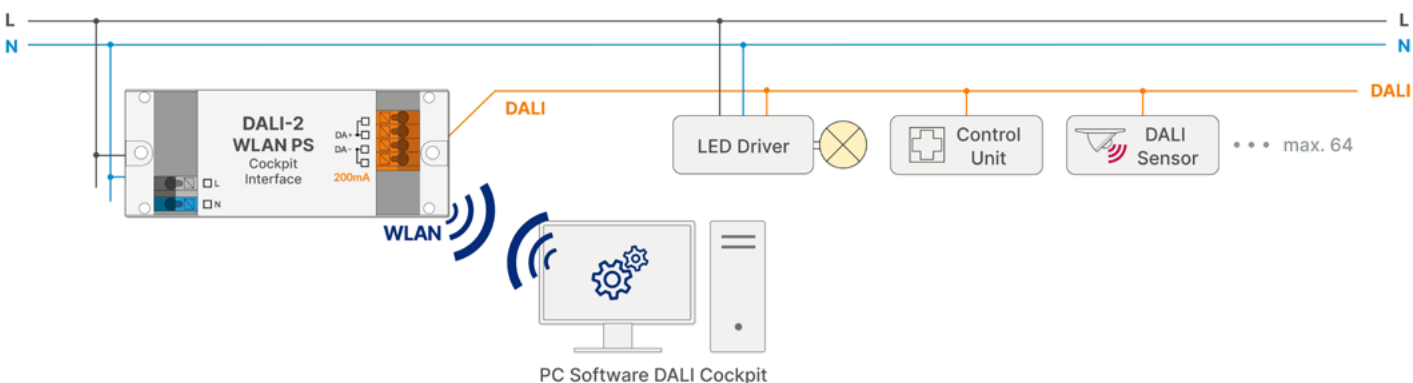

DALI 4Net - control of 4 DALI lines

The compact 1DU DIN rail module enables the independent control of up to 4 DALI lines, which equals 256 DALI operating devices. Efficient scaling is possible with external DALI bus supplies.

The DALI 4Net module enables cross-DALI line control using 15 cross-bus zones. The DALI groups from the 4 DALI lines can be assigned to these zones. This makes it possible to extend the effective range of a command beyond its DALI line.

Furthermore, the "Trigger Action" function of the DALI 4Net module enables control devices from one DALI bus to control areas of the other 3 DALI buses.

DALI devices and DALI LED dimmers can be configured via the PC software tool DALI Cockpit via the Ethernet interface of the DALI 4Net.

With the Modbus interface, the DALI 4Net can also be integrated into building management systems (BMS).

The DALI 4Net is available in a basic version with limited functions (see table), or in an extended version with real time clock (RTC), circadian daylight schedules (CDC), programmable



schedules, cross-line functions for input devices and sensors, emergency function and sensor value recording. Information from the DALI operating devices can be read and displayed using the PC software tool DALI Visual.

NAME	ARTICLE NUMBER	INTERFACE	POWER SUPPLY	BASIC FUNCTIONS	ADDITIONAL FUNCTIONS	DIMENSIONS (MM)
DALI 4Net Basic	22176666-B	4xDALI, Ethernet	24V DC	<ul style="list-style-type: none"> gateway Modbus ↔ DALI ModBus TCP control ModBus TCP queries zone definition (areas over multiple lines) 	-	98 × 17,5 × 57
DALI 4Net	22176666	4xDALI, Ethernet	24V DC		<ul style="list-style-type: none"> real time clock central scheduling cross-line functions circadian daylight schedule emergency function sensor value polling 	98 × 17,5 × 57

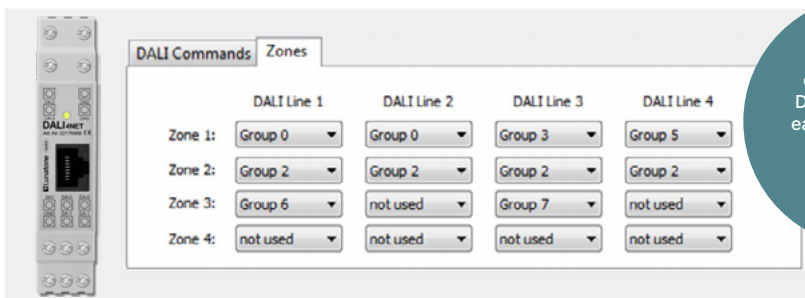
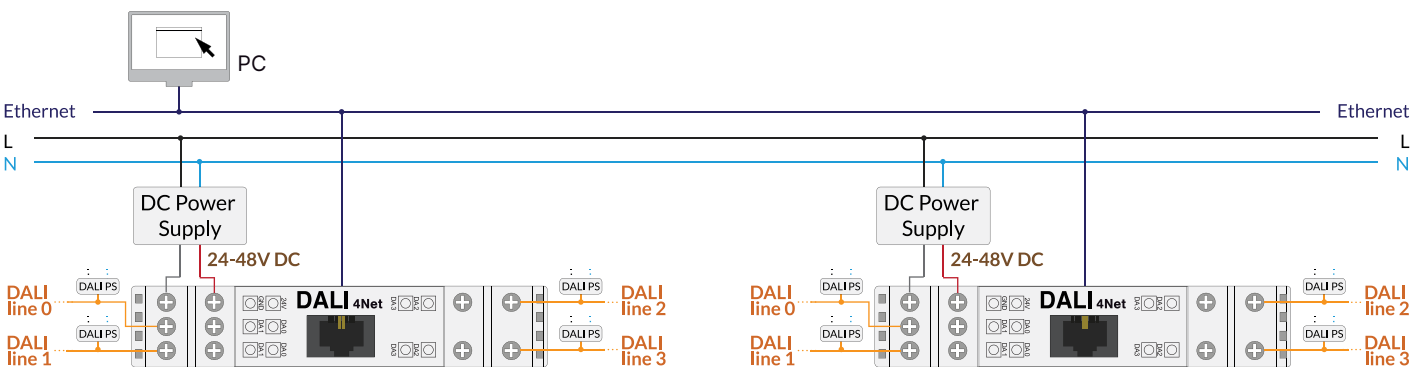

15 zones can be defined. DALI groups from each DALI line can be assigned to these zones.

"Cross-line operations" allow sending commands to multiple DALI lines or a user defined zone.

DALI-2 SCI RS232

Module with serial interface to communicate with the DALI bus via RS232. Enables, for example, the connection of a PLC to a DALI system via RS232 for bidirectional data transmission. Suitable for addressing, configuration, status queries and monitoring.

LUBA protocol: Intelligent protocol for easy access to the DALI system.

The DALI-2 SCI RS232 is suitable for DIN rail mounting.



NAME	ARTICLE NUMBER	POWER SUPPLY	TYP. DALI CURRENT CONSUMPTION	SCI	TYP. SUPPLY CURRENT SCI	OPERATING TEMPERATURE (TA)	MODEL	DIMENSIONS (MM)
DALI SCI RS232	22176438-HS	6-24V DC	typ. 10mA	<ul style="list-style-type: none"> RS232 38400 Baud, 8 data bits, 	typ. 5mA	-20°C ... +75°C	for DIN rail	98 × 17,5 × 57
DALI-2 SCI RS232 LUBA Protocol	24166096-LU-HS	6-24V DC	typ. 10mA	<ul style="list-style-type: none"> no parity, 1 stop bit (38400, 8, n, 1) 	typ. 5mA	-20°C ... +75°C	for DIN rail	98 × 17,5 × 57

DALI-2 RS232 PS - integrated DALI bus power supply

Module with serial interface to communicate with the DALI bus via RS232. Enables, for example, the connection of a PLC to a DALI system via RS232 for bidirectional data transmission. Suitable for addressing, configuration, status queries and monitoring. Housing variants with strain relief or DIN rail mounting are available. The PS variant has an integrated bus supply (240mA) for up to 64 standard DALI loads. **LUBA protocol:** Intelligent protocol for easy access to the DALI system.

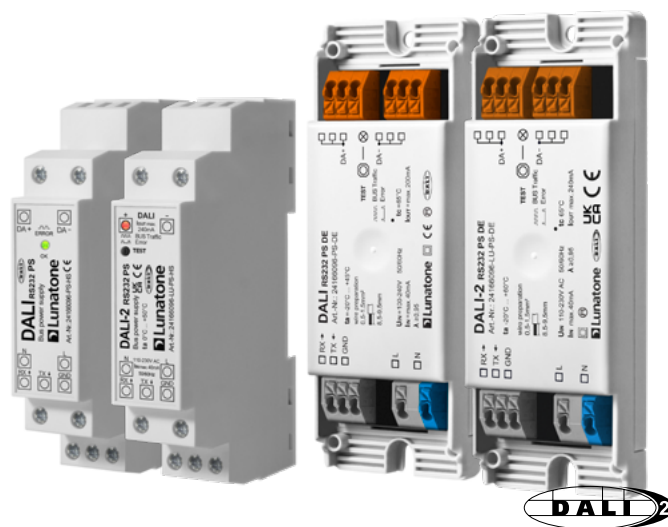

NAME	ARTICLE NUMBER	INPUT VOLTAGE	INTEGRATED DALI BUS SUPPLY	SCI	(TA) OPERATING TEMPERATURE	MODEL	DIMENSIONS (MM)
DALI RS232 PS240mA DIN rail	24166096-PS-HS	110-230V AC	240mA	<ul style="list-style-type: none"> RS232 	-0°C ... +50°C	for DIN rail	59 × 33 × 15
DALI RS232 PS240mA	24166096-PS-DE	110-230V AC	240mA	<ul style="list-style-type: none"> 38400 Baud, 8 data bits, 	-20°C ... +60°C	with strain relief for suspended ceilings	120 × 41 × 22
DALI-2 RS232 PS240mA DIN rail, LUBA Protocol	24166096-LU-PS-HS	110-230V AC	240mA	<ul style="list-style-type: none"> no parity, 1 stop bit (38400, 8, n, 1) 	-0°C ... +50°C	for DIN rail	59 × 33 × 15
DALI-2 RS232 PS240mA, LUBA Protocol	24166096-LU-PS-DE	110-230V AC	240mA		-20°C ... +60°C	with strain relief for suspended ceilings	120 × 41 × 22

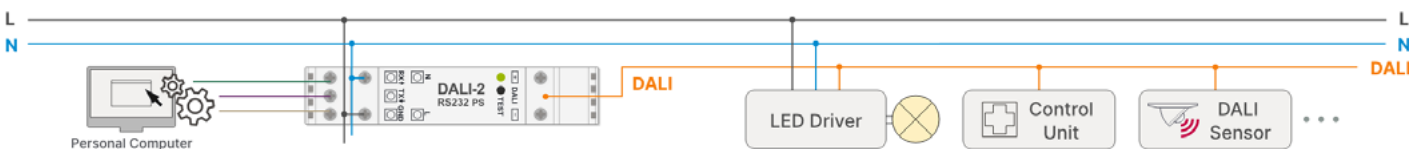

DALI-2 IoT Gateway

The DALI-2 IoT Gateway is an interface to connect the DALI system with smart devices via the Internet of Things (IoT). For this purpose, the DALI-2 IoT Gateway offers RESTful API endpoints and WebSocket connection with JSON syntax. In addition to simple DALI addressing and communication via the API, it is also possible to create sequences and timer entries. A detailed interface documentation is available. The DALI-2 IoT Gateway makes it possible to easily integrate the DALI system into a higher-level, intelligent system in which DALI devices can be controlled and monitored via smartphones or PCs.



NAME	ARTICLE NUMBER	INTERFACE	POWER SUPPLY	OPERATING TEMPERATURE (TA)	DIMENSIONS (MM)
DALI-2 IOT Gateway	89453886	DALI, Ethernet	24V-48V DC	-20°C ... +60°C	98 × 17,5 × 57
DALI-2 IOT Gateway Node-RED	89453886-NR	DALI, Ethernet, Node-RED	24V-48V DC	-20°C ... +60°C	98 × 17,5 × 57

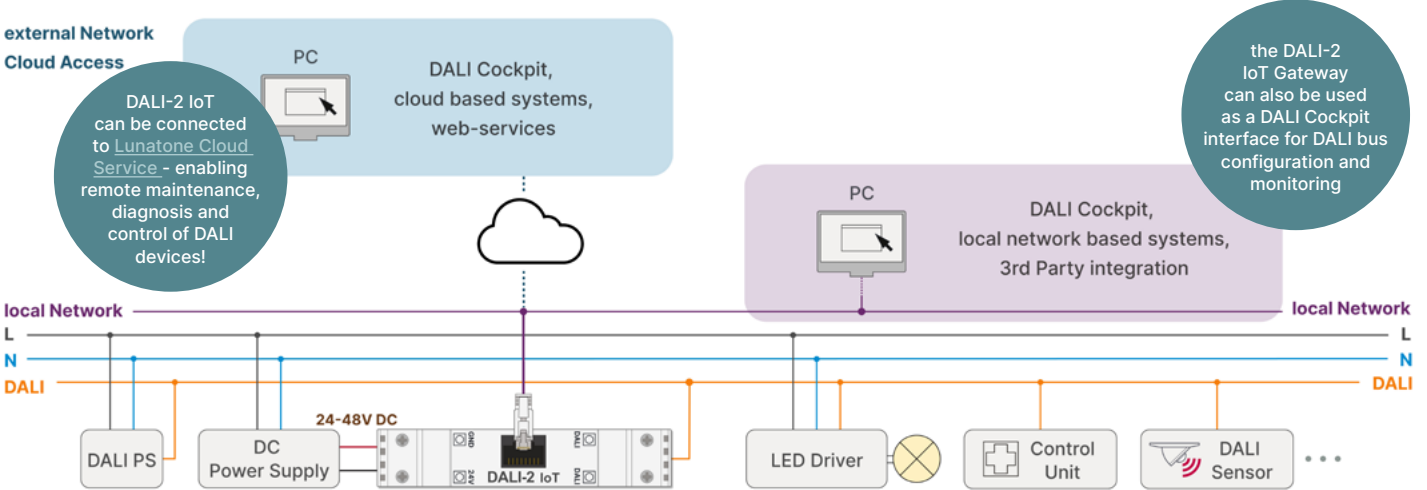

EASY IMPLEMENTATION OF AUTOMATIONS WITH DALI-2 IOT GATEWAY NODE-RED

In addition to the standard functions of the DALI-2 IoT, the DALI-2 IoT Node-RED offers an integrated Node-RED server. The user-friendly and browser-based Node-RED editor allows an easy creation of automations between Lunatone DALI nodes and any other custom nodes.

The Node-RED editor provides a canvas where users can drag and drop nodes, connecting them to create flows, systems and automations, such as linking several DALI-2 IoTs, DALI4 Nets, IoT to KNX interfaces, Zigbee, Philips Hue,... and thus replaces any central control. A collection of examples is available at <https://www.lunatone.com/en/product/dali-2-iot-gateway/>

Moreover, the Node-RED editor allows the creation of custom user interfaces (dashboards) for monitoring and operation. Link widgets can be created making the application accessible on smartphones and PCs within the same network as the IoT devices.



Smartphone link widget to Node-RED dashboard

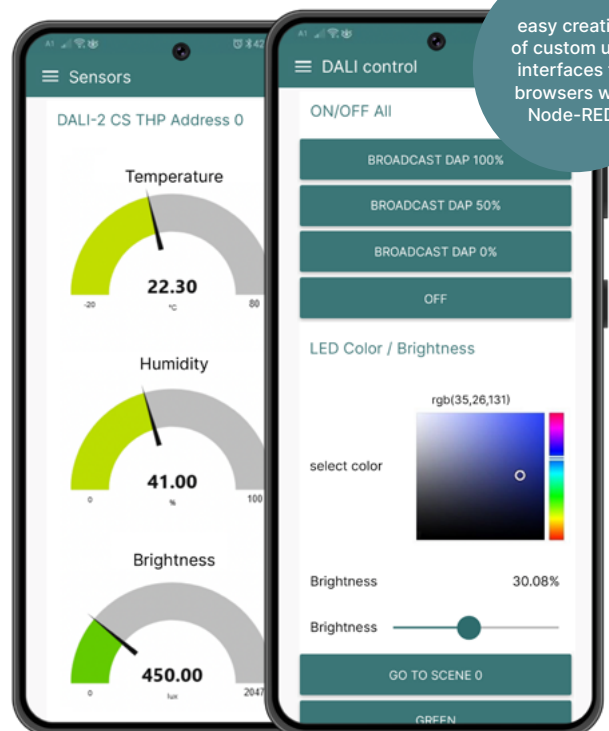

easy creation of custom user interfaces for browsers with Node-RED!

Node-RED configuration: creating flows & automations with the help of "nodes"

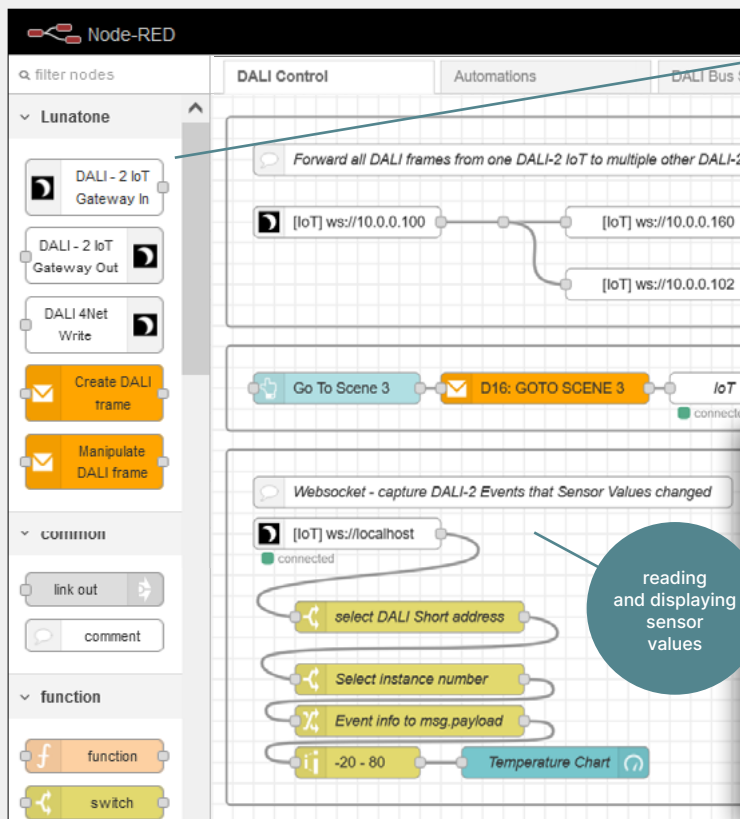

- predesigned Lunatone nodes (= building blocks) for DALI communication and linking
- simple forwarding between DALI systems
- creation of control elements for a custom user interface
- example of a custom user interface (accessible via PC and smartphone)

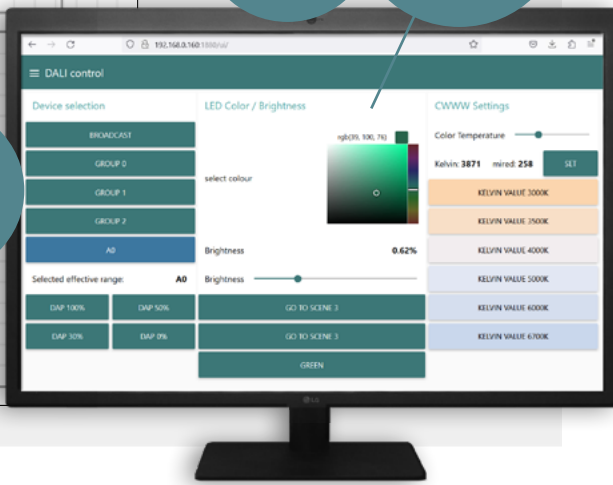

reading and displaying sensor values

KNX DALI-2 Gateway

The KNX DALI-2 Gateway is DALI multi-master capable and can transmit commands bidirectional from KNX to DALI and vice versa. The DALI system and the individual DALI devices can be configured with the DALI Cockpit PC software and a suitable interface to the DALI bus (e.g. DALI USB). The configuration of the KNX system can be done with the provided product database for ETS5. The data point types that match the DALI devices can be set in ETS5 and linked to the KNX components. All DALI device types (DT6, DT8-CW-WW, RGB, RGBW, RGBWAF, X-Y) are supported.



NAME	ARTICLE NUMBER	INTERFACE	CURRENT CONSUMPTION	OPERATING TEMPERATURE (TA)	DIMENSIONS (MM)
KNX DALI-2 Gateway	89453899	DALI, KNX	via DALI bus: typ. 3mA via KNX: typ. 6mA	-20°C - +75°C	98 × 17,5 × 57

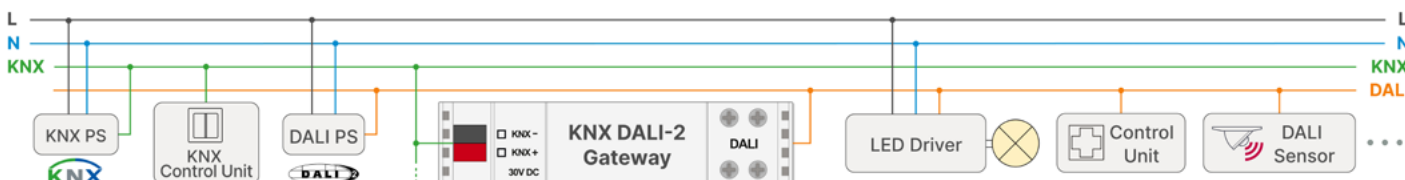

KNX 4 DALI Gateway

The gateway enables broadcast control of 4 DALI lines, each with up to 4 DALI operating devices. These 4 DALI lines are supplied with the integrated DALI bus supply of the KNX 4 DALI Gateway. If needed, the number of devices can be extended with a DALI Expander. The configuration of the DALI-KNX Gateway can be done with the provided product database for ETS5. The data point types that match the DALI devices can be set in ETS5 and linked to the KNX components. Colour temperature control (DT8: CW-WW), colour control (DT8: RGB, RGBW) as well as the control of other light sources (DT0, DT2, DT3, DT4, DT6) are supported. DALI scene recalls are possible with KNX communication objects for scenes.



NAME	ARTICLE NUMBER	INTERFACE	INPUT VOLTAGE RANGE	OUTPUT	DALI BUS POWER SUPPLY	OPERATING TEMPERATURE (TA)	DIMENSIONS (MM)
KNX 4 DALI Gateway	89451312	DALI, KNX	DC 21...32V SELV	4x DALI	10mA	-20°C - +60°C	120 × 41 × 22

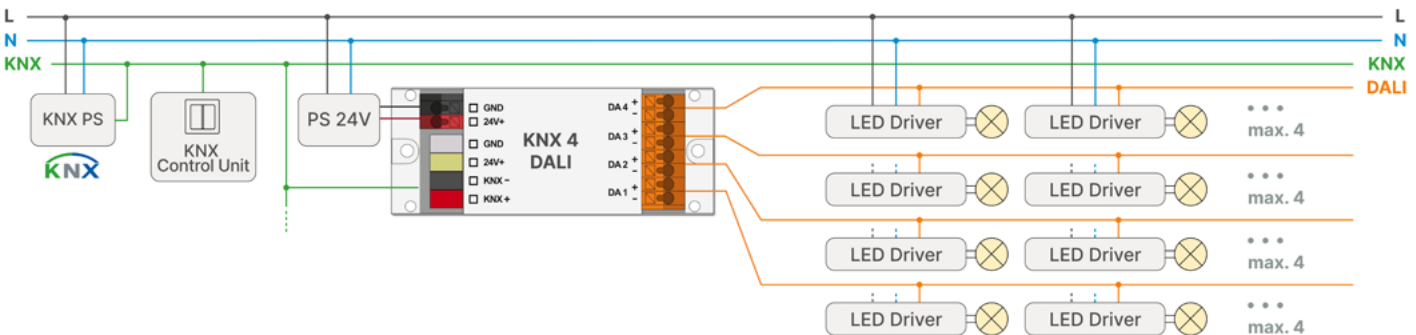

DALI-2 KNX Room Controller

The module enables commissioning, configuration and control of a DALI system via Bluetooth using the smartphone application DALI Cockpit Mobile.

The Lunatone smartphone application DALI Cockpit Mobile offers a clear and simple interface with a DALI installation assistant, various DALI configuration options and a configurable user interface to control connected DALI devices.

The module offers a KNX TP interface, which enables switching, dimming and scene control via KNX. Up to 8 gate functionalities can be implemented using the product database (ETS5/6). Each gate supports all DALI addressing types. Various KNX status objects are available for visualization.

The module has an integrated bus supply (200mA) for a DALI system of up to 64 DALI devices. The independent control gear is suitable for remote ceiling installation or integration in luminaires.



NAME	ARTICLE NUMBER	INTERFACE	INPUT SUPPLY CURRENT	OPERATING TEMPERATURE (TA)	DIMENSIONS (MM)
DALI-2 BT5 Room Controller KNX	87454427-KX	DALI, KNX, Bluetooth	mains voltage 40mA (@120Vac), 20mA (@240Vac)	-10°C ... +55°C	159 × 42 × 22

Installation example:

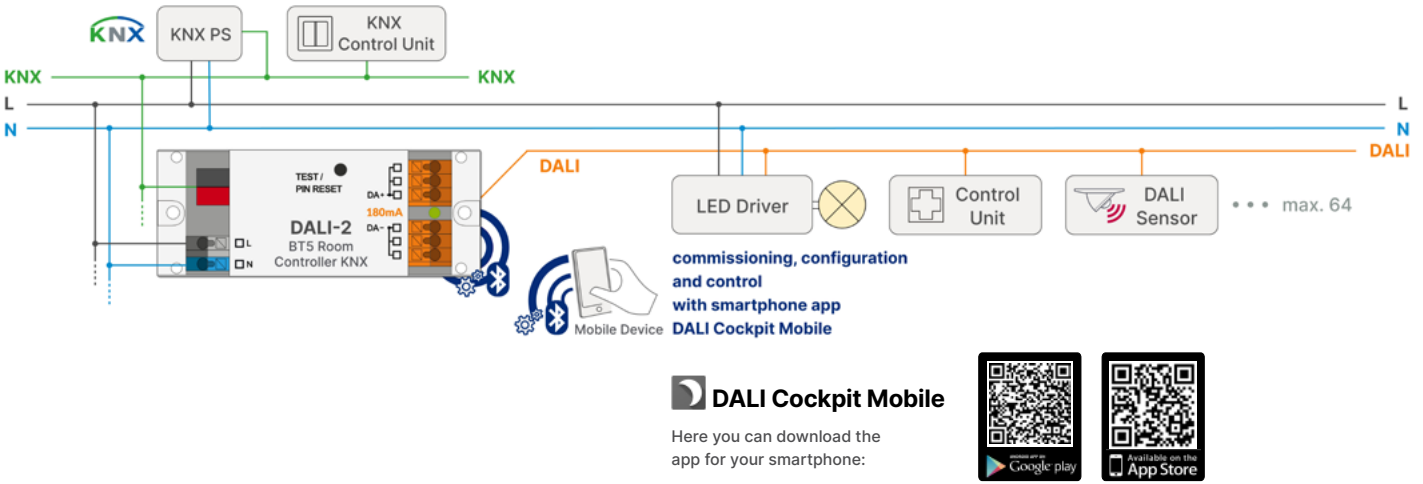

DALI Cockpit Mobile

Here you can download the app for your smartphone:



DALI-2 Room Controller

The DALI-2 Room Controller serves as an interface between Bluetooth 5.0 and DALI. The device is ideal for room solutions. The supply as well as commissioning, configuration and control of a small DALI system can be easily implemented with this device.

The module has an integrated DALI bus supply (200mA) to operate up to 64 DALI devices. A connection to the Lunatone smartphone application DALI Cockpit Mobile can be established via the Bluetooth interface. The app offers a clear and simple user interface with an installation wizard, various configuration options and a customizable user interface to control connected devices.

The independent control gear is suitable for remote ceiling installation or integration in luminaires.



NAME	ARTICLE NUMBER	INTERFACE	INPUT SUPPLY CURRENT	OPERATING TEMPERATURE (TA)	DIMENSIONS (MM)
DALI-2 BT5 Room Controller	87454427	DALI, Bluetooth	mains voltage 40mA (@120Vac), 20mA (@240Vac)	-20°C ... +75°C	120 × 41 × 22

Installation example:

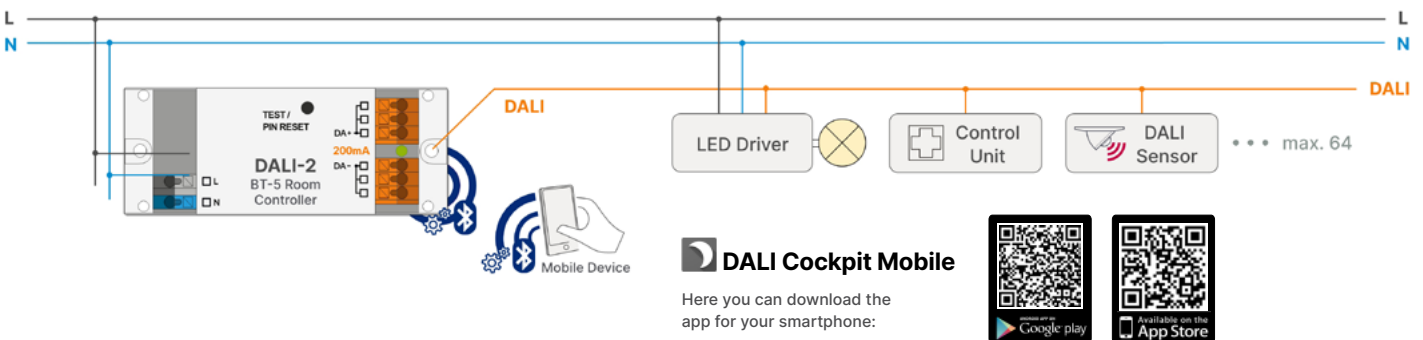

DALI Cockpit Mobile - Smartphone application

Smartphone application for easy setup and configuration of DALI systems in connection with the DALI-2 BT5 Room Controller. The DALI system can be addressed, configured and controlled via the app. In addition, a customizable user interface can be created for light control via mobile phone.



DALI Cockpit Mobile

Here you can download the app for your smartphone!



customizable user interface for light control

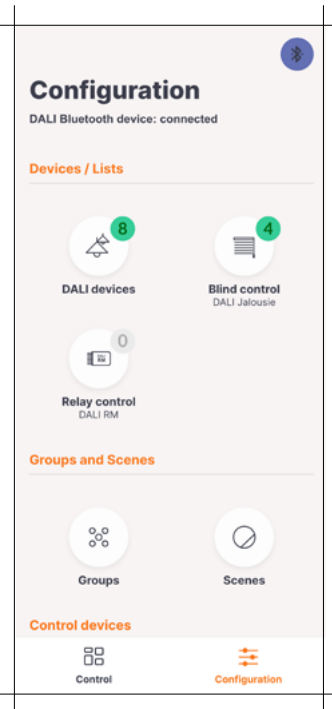

menu with various sub-items for device configuration

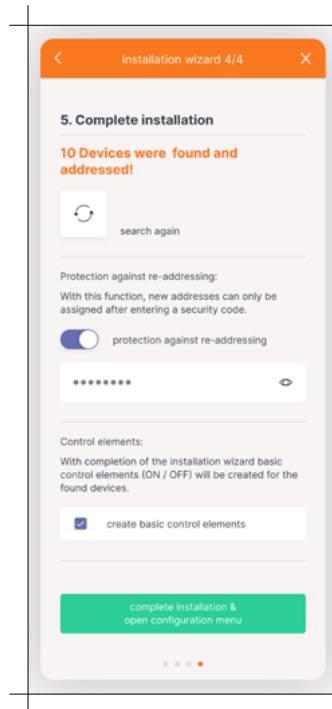

installation assistant for device addressing

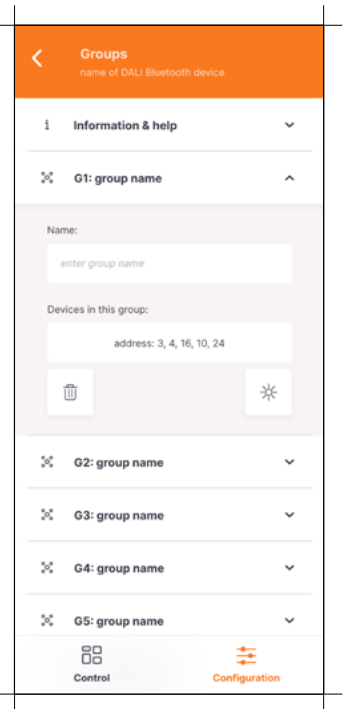

configuration page for DALI groups

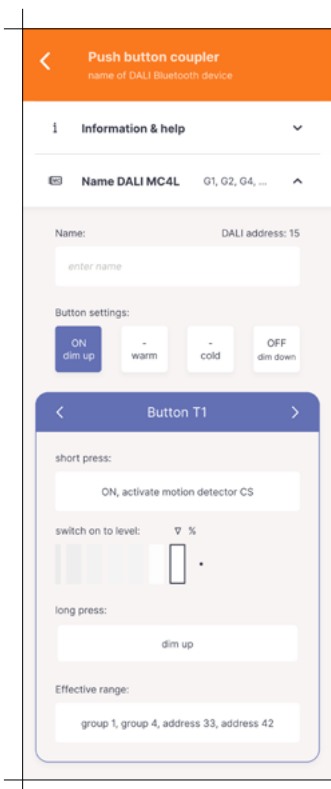

settings page of push button coupler DALI-2 MC4L

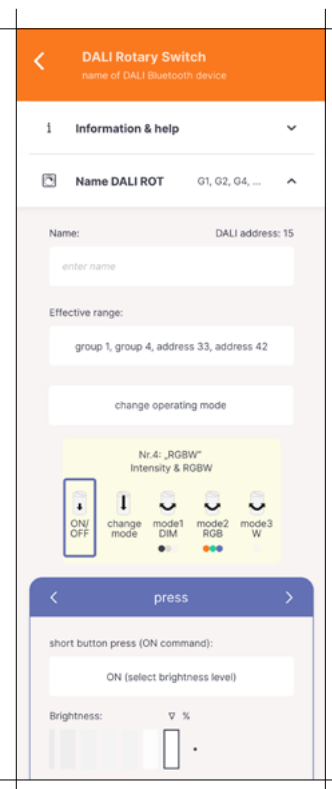

settings page of push & rotary switch DALI-2 ROT

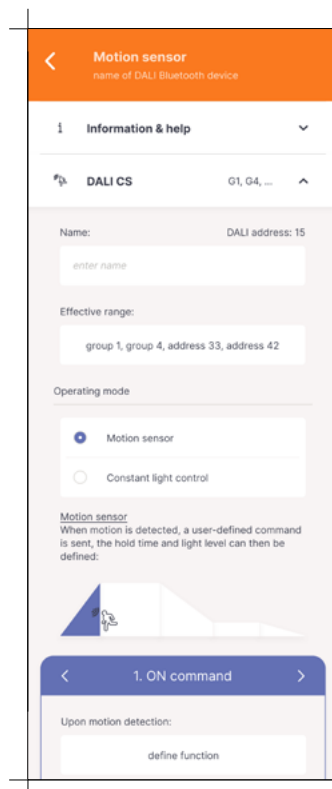

settings page of motion sensor DALI-2 CS

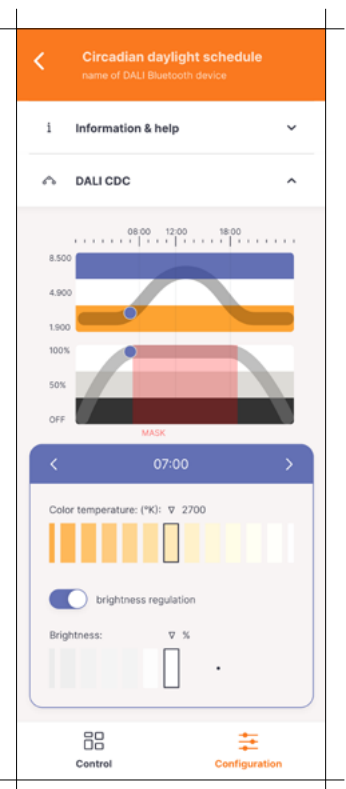

settings page for circadian daylight schedule - DALI CDC

DALI Daylight Bluetooth Interface

DALI Daylight Interface incl. App for iOS and Android allows basic adjustment of the following devices:

- DALI CDC: changing circadian curve settings (start, peak, end)
- DALI RTC: definition of 2 switching intervals per weekday
- DALI CS: setting light level and hold time
- DALI LS: switching between manual and automatic light level control, specifying the reference light level



DALI Daylight

Here you can download the app for your smartphone!



NAME	ARTICLE NUMBER	INPUT SUPPLY CURRENT	TYP. DALI CURRENT CONSUMPTION	DIMENSIONS (MM)
DALI Daylight Bluetooth Interface	89453863	via DALI line	typ. 4mA	59 × 33 × 15

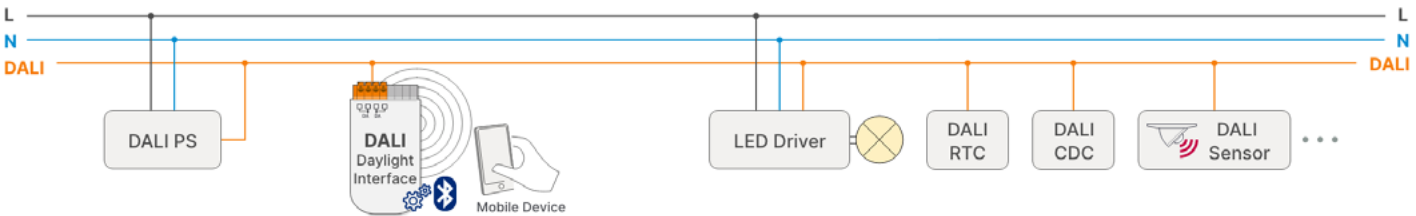

DALI-2 Audio Interface

DALI-2 device for playing internet radio stations. Speakers or intercom systems can be easily connected via a corresponding connector. The control of radio stations and volume works via DALI. Up to 16 internet radio stations can be accessed via scenes. The WLAN interface is used for integration into the local network and to access the internet radio stations.

Configurations can be made with the Lunatone PC software DALI Cockpit.

The device is suitable for remote ceiling installation or integration in luminaires.



NAME	ARTICLE NUMBER	INTERFACE	INPUT SUPPLY CURRENT	OPERATING TEMPERATURE (TA)	DIMENSIONS (MM)
DALI-2 Audio Interface	89943721	DALI, WLAN	mains voltage 31mA (@110Vac), 21mA (@240Vac)	-20°C ... +60°C	159 × 41 × 22

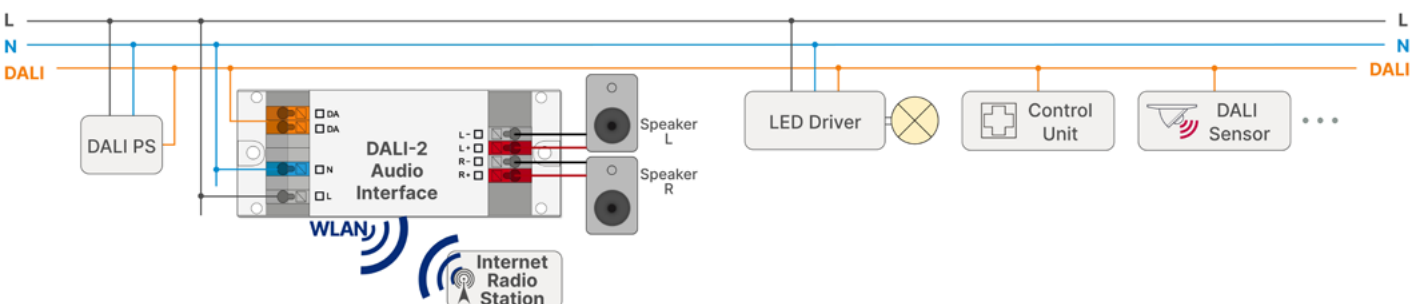

DALI SI, SI-1L

Sensor Interface to connect e.g. conventional motion sensors, contact switches or photoelectric sensors to a DALI system. Configuration options are similar to the DALI CS: effective range, target address, DALI commands for on/off and hold times, light levels etc. Multiple sensors within one group synchronise automatically. Two different versions are available, one with switching input for potential free contacts (DALI SI), the other with switching input for mains voltage (DALI SI1L). The device is designed to fit behind a light switch in a flush-type installation box.



NAME	ARTICLE NUMBER	INPUT SUPPLY CURRENT	TYP. DALI CURRENT CONSUMPTION	CONTROL INPUT	DIMENSIONS (MM)
DALI SI	89453850	via DALI line	2,9mA	1 switching input for potential free contact	40 × 28 × 15
DALI SI-1L	89453850-1L	via DALI line	2,9mA	1 switching input for mains voltage	59 × 33 × 15

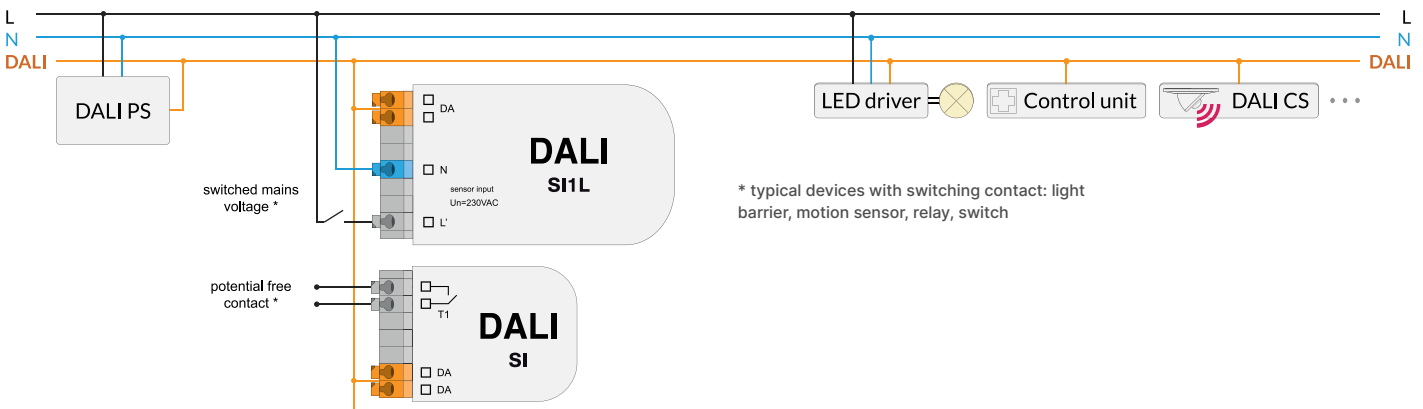

DALI DSI - converting DALI to DSI

DALI DSI converts DALI commands to DSI signals to enable the integration of DSI-based operating devices into a DALI system. The DALI DSI obtains its own address and can be assigned to groups as well as scenes. The compact device is designed to fit in flush-type installation boxes.



NAME	ARTICLE NUMBER	INPUT SUPPLY CURRENT	TYP. DALI CURRENT CONSUMPTION	DIMENSIONS (MM)
DALI DSI	24034689	via DALI line	16 mA	41×30×11

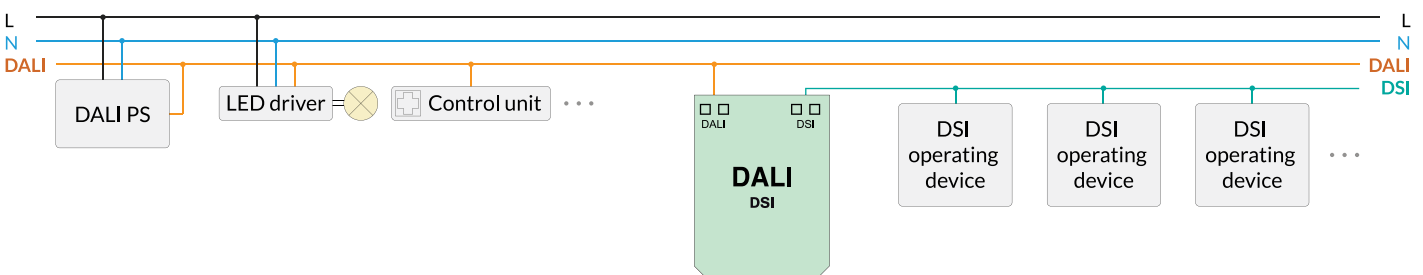

DALI Dim2warm - converting DT6 dimming commands into two DT6 control signals

With only one DT6 DALI address, the Dim2Warm module allows the simultaneous control of brightness while changing the colour temperature. The lower the dimming value, the warmer the light. The output curves of the two channels can be individually adjusted via the DALI Cockpit.

This device can also be used for direct and indirect lighting with just one DALI address.



NAME	ARTICLE NUMBER	CURRENT CONSUMPTION DALI	OUTPUT	OPERATING TEMPERATURE (TA)	DIMENSIONS (MM)
DALI Dim2warm	89453864	4.5mA + current consumption subnet	2xDALI	-20°C ... +60°C	40 × 28 × 15

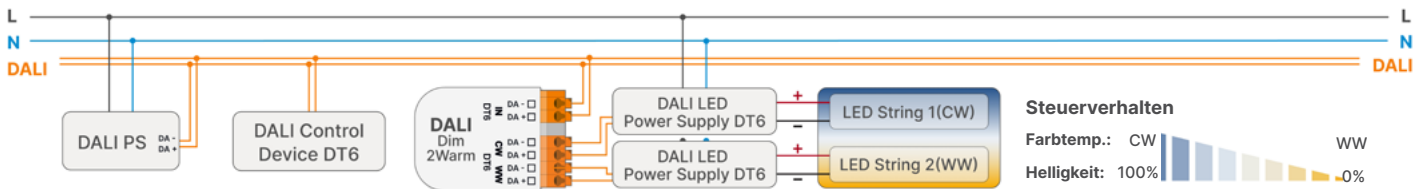

DALI DT8 to DT6 - converting DT8-Tc commands into two DT6 control signals

DALI interface module for converting DT8-Tc control commands into DT6 control signals.

The module allows dimming and adjustment of colour temperature via DT8 commands.

Also suitable for lights with two DALI DT6 operating devices. Factory setting: separate outputs for cold-white and warm-white channel.



NAME	ARTICLE NUMBER	CURRENT CONSUMPTION DALI	OUTPUT	OPERATING TEMPERATURE (TA)	DIMENSIONS (MM)
DALI DT8 to DT6	89453859	4.5mA + current consumption subnet	2xDALI	-20°C ... +60°C	40 × 28 × 15

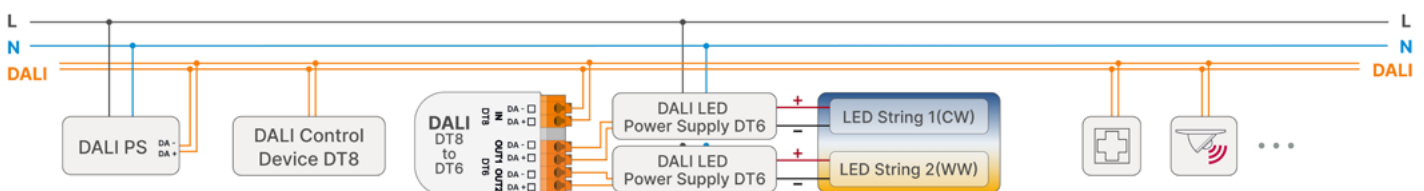

0-10V DALI - converting 0-10V to DALI with integrated 10mA bus power supply

This compact module converts analogue 0-10V control signals into DALI dim levels. The device has an active and a passive input for 0-10V. The converted values are sent broadcast to the entire DALI system. With the integrated bus supply a small DALI system with up to 4 standard DALI devices (10mA) can be supplied. The interface module is supplied by a 12-24V power supply. Versions with different dimming ranges, such as 1%-100% or 10%-100%, and different DALI functionality at input voltages <1V are available.



NAME	ARTICLE NUMBER	SUPPLY VOLTAGE	FUNCTION IF VOLTAGE <1V	DIMMING RANGE	INTEGRATED DALI POWER SUPPLY	DIMENSIONS (MM)
0-10V to DALI Converter	86468352-001	12 - 24V DC	OFF	1 - 100 %	10mA	40 × 28 × 15
0-10V to DALI Converter	86468352-010	12 - 24V DC	OFF	10 - 100 %	10mA	40 × 28 × 15
0-10V to DALI Converter	86468352-101	12 - 24V DC	MIN	1 - 100 %	10mA	40 × 28 × 15
0-10V to DALI Converter	86468352-110	12 - 24V DC	MIN	10 - 100 %	10mA	40 × 28 × 15

NAME	ARTICLE NUMBER	INPUT VOLTAGE	MAX. OUTPUT CURRENT	OUTPUT VOLTAGE	MODEL	DIMENSIONS (MM)
24V Power Supply	24166012-24	230V AC	300 mA	24V DC	for flush-type installation boxes	59 × 33 × 15
24V Power Supply DIN rail	24166012-24HS	230V AC	50 mA	24V DC	for DIN rail	98 × 17,5 × 57

typical application with 0-10V voltage at the passive 0-10V input

(0-10V control device = voltage source, e.g.: SPS)

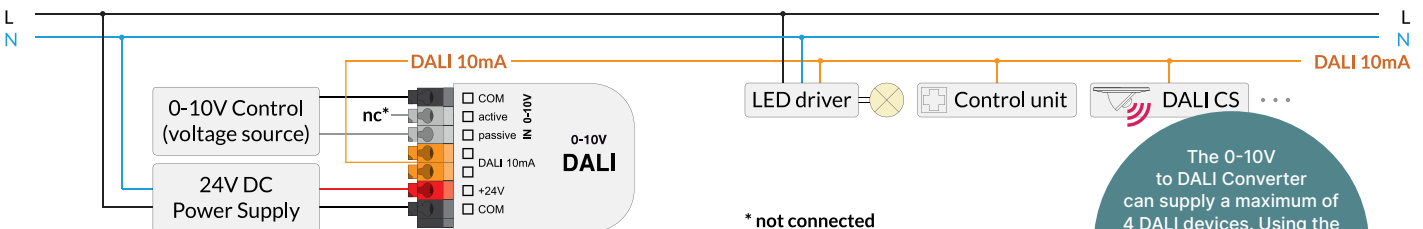

The 0-10V to DALI Converter can supply a maximum of 4 DALI devices. Using the DALI Expander up to 64 DALI devices can be controlled via the 0/ 1-10V signal. folder D, page 4

typical application with 100k potentiometer at the active 0-10V input

(0-10V control device = load)

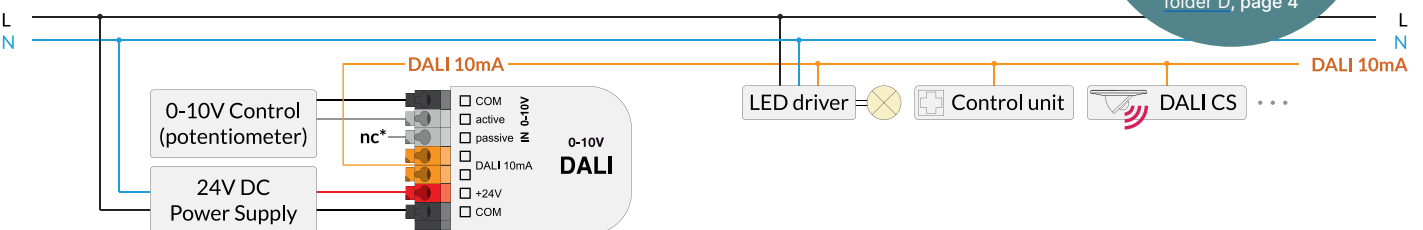

example: Control of DALI luminaires with xComfort by EATON

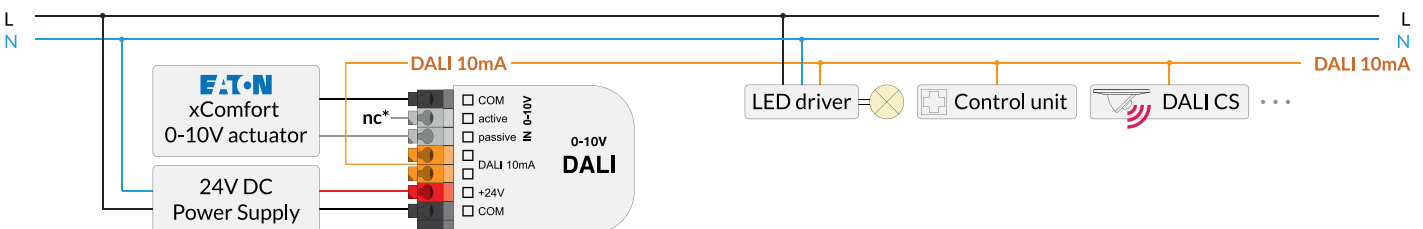

0-10V DALI - converting 0-10V to DALI with 1, 2 or 3 channels

The compact module converts analogue 0-10V control signals into DALI dim levels (direct arc power - DAP). The device has an active and a passive input for 0-10V. The converted values are sent broadcast to the entire DALI system. With the integrated bus supply (30mA) a small DALI system with up to 10 standard DALI devices can be realised. The interface module is supplied by a 12-24V power supply. The device functionality can be changed with the help of jumpers: dimming range 1-100% or 10-100% and at input voltages <1V: off or minimum. An additional configuration with the DALI Cockpit software is not possible.



NAME	ARTICLE NUMBER	SUPPLY VOLTAGE	FUNCTION IF VOLTAGE <1V	DIMMING RANGE	INTEGRATED DALI POWER SUPPLY	MODEL	DIMENSIONS (MM)
0-10V to DALI Converter 30mA	86468352-HS	12 - 24V DC	variabel (jumper)	variabel (jumper)	30mA	for DIN rail	98 × 17,5 × 57

Changing the dimming characteristic via jumpers by connecting either M1, M2, M3:

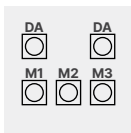

V1: Dimming: 1-100% <1V: OFF (equiv. red curve)

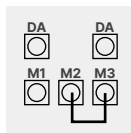

V2: Dimming: 10-100% <1V: OFF (red curve)

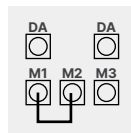

V3: Dimming: 1-100% <1V: MIN (1%) (equiv. blue curve)

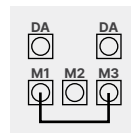

V4: Dimming: 10-100% <1V: MIN (10%) (blue curve)

0-10V / DALI Conversion

The light level corresponds to the output power of a standard DALI device connected to the converter (according to IEC62386-102).

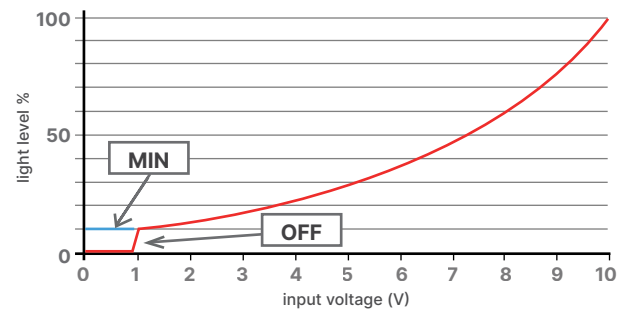

0-10V DALI - converting 0-10V to DALI with integrated 30mA bus power supply

The compact module converts analogue 0-10V control signals into DALI dim levels (direct arc power - DAP). The device is available with up to 3 input channels to integrate multiple 0-10V devices into the DALI System. Effective range, conversion curve and functionality at input voltages <1V can be set with the DALI Cockpit software.

Factory settings: Dimming range 1-100%, at input voltages <1V off-command is sent. The interface module is supplied by a 12-24V power supply. An additional DALI bus power supply is required for the DALI line, [see folder D](#), page 2.



NAME	ARTICLE NUMBER	SUPPLY VOLTAGE	NR. 0-10V CHANNELS	FUNCTION IF VOLTAGE <1V	DIMMING RANGE	MODEL	DIMENSIONS (MM)
1 Channel 0-10V to DALI Converter	86468353-1-HS	12 - 24V DC	1 channel	OFF (configurable)	1%-100% (configurable)	for DIN rail	98 × 17,5 × 57
2 Channel 0-10V to DALI Converter	86468353-2-HS	12 - 24V DC	2 channels	OFF (configurable)	1%-100% (configurable)	for DIN rail	98 × 17,5 × 57
3 Channel 0-10V to DALI Converter	86468353-3-HS	12 - 24V DC	3 channels	OFF (configurable)	1%-100% (configurable)	for DIN rail	98 × 17,5 × 57

4-20mA to DALI Converter - 24V, integrated 30mA bus power supply

This compact module converts 4-20mA signals to DALI dim levels. The 4-20mA current value is sent broadcast as a dimming value on the DALI bus.

The module has an integrated bus power supply (30mA) for a small DALI system with up to 10 standard DALI ballasts.

The configuration of the dimming characteristics is possible with the help of jumpers. An additional configuration with the DALI Cockpit software is not possible.

The interface module requires a 12- 24V power supply (e.g. 24V/300mA Art.Nr. 24166012-24HS)



NAME	ARTICLE NUMBER	SUPPLY VOLTAGE	EVENT TRIGGER	DIMMING RANGE	INTEG. DALI BUS-VERSORGUNG	MODEL	DIMENSIONS (MM)
4-20mA to DALI Converter, 24V	86468334-24-HS	12 - 24V DC	change in the 4-20mA input signal (>1%)	variabel (jumper) see 86468352-HS	30mA	for DIN rail	98 × 17,5 × 57

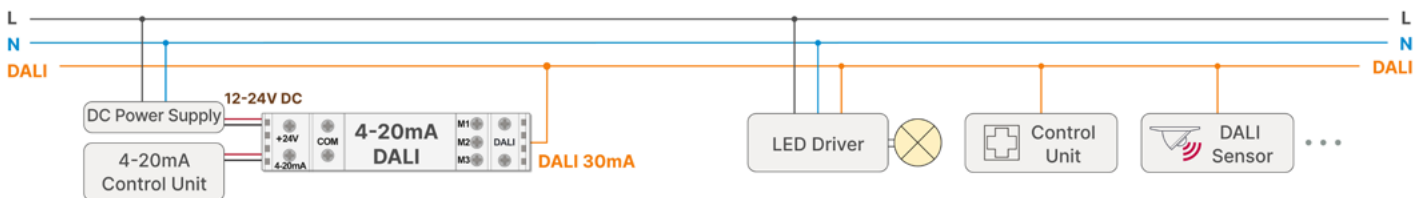

4-20mA to DALI Converter - 230V, integrated 30mA bus power supply

This compact module converts 4-20mA signals to DALI dim levels. The 4-20mA current value is sent broadcast as a dimming value on the DALI bus.

The module has an integrated bus power supply (30mA) for a small DALI system with up to 10 standard DALI ballasts.

The configuration of the dimming characteristics is possible with the help of jumpers. An additional configuration with the DALI Cockpit software is not possible.

The module can be supplied with 230V mains voltage.

4-20mA input and DALI bus are galvanically isolated from each other as well as from the mains.



NAME	ARTICLE NUMBER	SUPPLY VOLTAGE	EVENT TRIGGER	DIMMING RANGE	INTEG. DALI BUS-VERSORGUNG	MODEL	DIMENSIONS (MM)
4-20mA to DALI Converter, 230V	86468334-230-HS	110Vac - 230Vac	change in the 4-20mA input signal (>1%)	variabel (jumper) see 86468352-HS	30mA	for DIN rail	98 × 17,5 × 57

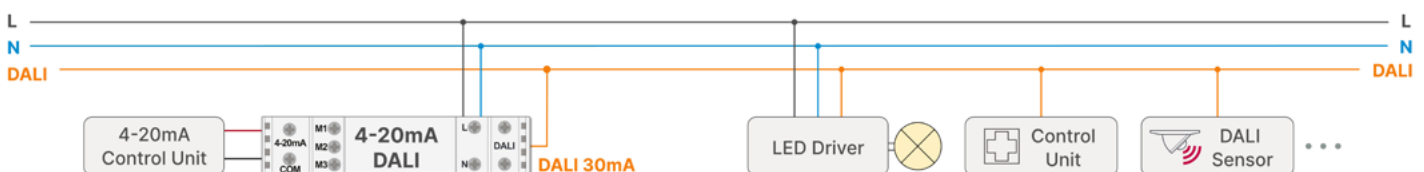

DALI RM8 / RM16 0-10V - relay modules with 0-10V control input

0-10V interface with 8A or 16A relay. This interface converts DALI signals into 1-10V control signals and thus enables the integration of devices with 1-10V control input into a DALI system. With the integrated switching relay, the power supply of the operating devices can be switched on and off. The modules are compliant with DALI Device Type 5 (IEC62386-206). The Linear or logarithmic dimming curve as well as the 0-10V or 1-10V control voltage range are adjustable via the DALI Cockpit software. The devices with PWM (see table) can also control operating devices with PWM input. The DALI input is galvanically isolated from the PWM/1-10V output.



NAME	ARTICLE NUMBER	SWITCHING CURRENT RELAY CONTACT	TYPE OF RELAY CONTACT	OUTPUT (0-10V)	MODEL	DIMENSIONS (MM)
DALI RM8 PWM	86458668	max. 8A	1 on/off	0-100% PWM (14Bit, 488Hz), current sink 2mA	for flush-type installation boxes	59 x 33 x 15
DALI RM8 1-10V AN	86458668-AN	max. 8A	1 on/off	1-10V analog, current sink 1mA	for flush-type installation boxes	59 x 33 x 15
DALI RM16 1-10V with Wieland connectors	86458936	max. 16A	1 on/off	0-100% PWM (14Bit, 488Hz), current sink 2mA	with Wieland connectors	85 x 22 x 60
DALI RM16 0-10V PWM DE	86458667-DE	max. 16A	1 on/off	0-100% PWM (14Bit, 488Hz), current sink 2mA	with strain relief for suspended ceilings	120 x 30 x 22

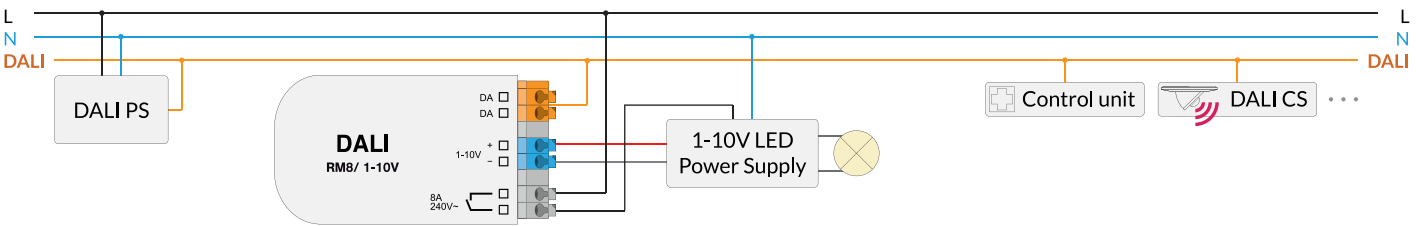

DALI RM8 / RM16 2x0-10V - operating 2 devices with 0-10V control input

This interface converts DALI signals into a 1-10V control signal and allows the integration of operating devices with two 1-10V control inputs for brightness and colour temperature into a DALI system. Output mode for channel1 / channel2 can be defined as either Brightness/Tc or separate channels for CW and WW.



NAME	ARTICLE NUMBER	SWITCHING CURRENT RELAY CONTACT	TYPE OF RELAY CONTACT	OUTPUT (1-10V)	MODEL	DIMENSIONS (MM)
DALI RM16 2x0-10V DIN rail	89453857-HS	max. 16A	1 normally open	channel 1: 1-10V analog, current sink 1mA	for DIN rail	98 x 17,5 x 57
DALI RM16 2x0-10V DE	89453857-DE	max. 8A	1 normally open	channel 2: 1-10V analog, current sink 1mA	with strain relief for suspended ceilings	120 x 30 x 22

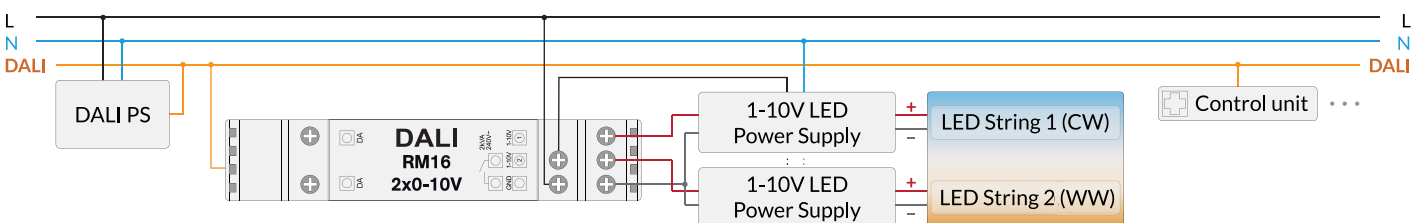

wDALI RM8 0/1-10V PWM - wireless relay module with 0/1-10V PWM control output

Wireless 0-10V PWM interface with integrated 8A relay. The set consists of a transmitter and a receiver and is used to wirelessly control lights with 0-10V / 1-10V / PWM operating devices.

The transmitter is connected to and powered by the DALI bus (3.8mA). The receiver has a 0-10V PWM output and a relay function and is powered by mains voltage.

The wDALI RM8 0-10V enables the wireless integration of electrical devices such as floor lamps and outdoor lighting into a DALI system. Under optimal conditions the reception range is 300m, in buildings usually 10-20m.



NAME	ARTICLE NUMBER	SWITCHING CURRENT RELAY CONTACT	TYPE OF RELAY CONTACT	OUTPUT (0-10V)	MODEL	DIMENSIONS (MM)
wDALI RM8 0-10V PWM + Transmitter	89453852+T	max. 8A	1 on/off	0-100% PWM (16Bit, 488Hz), current sink 1mA	for flush-type installation boxes	59 x 33 x 15

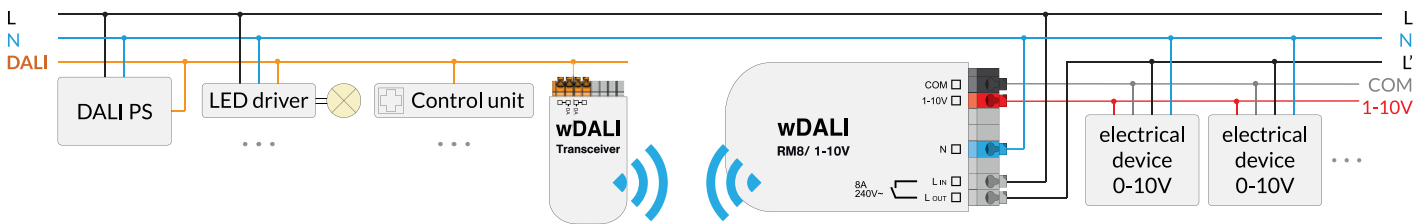

DALI Jalousie - 230VAC

The DALI Jalousie module can be used to control blind motors with 230V control input via DALI. Four configurable profiles can be programmed to open/close the blinds and to change the tilt angle. Different versions suitable for DIN rail mounting or remote ceiling installation (housing with strain relief) are available.



NAME	ARTICLE NUMBER	SUPPLY	TYP. DALI CURRENT CONSUMPTION	OPERATING TEMPERATURE (TA)	MODEL	DIMENSIONS (MM)
DALI Jalousie DIN rail	86458676+HS	via DALI line	5,5mA	-20°C ... +60°C	for DIN rail	98 x 17,5 x 57
DALI Jalousie	86458676-DE	via DALI line	5,5mA	-20°C ... +60°C	with strain relief for suspended ceilings	120 x 30 x 22

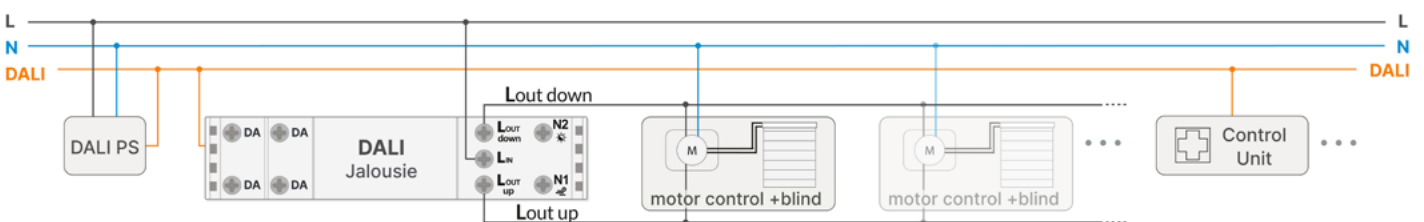

DALI 0/1-10V - converting DALI to 0-10V, 1-10V or PWM

These interfaces convert DALI signals into 0-10V, 1-10V or PWM control signals, thus enabling the integration of electrical devices with 0-10V control inputs into a DALI system, options listed in table below.

A single module can control up to 10 ballasts. The output voltage range as well as linear or logarithmic dimming curve can be adjusted via the DALI Cockpit software.



NAME	ARTICLE NUMBER	SIGNAL	SIGNAL RANGE	I/O SIGNAL	GALVANIC ISOLATION	MODEL	DIMENSIONS (MM)
DALI 0-10V LE	86458508-LE	analog	0 - 10V	current sink: max. 1mA	no	for flush-type installation boxes	40 x 28 x 15
DALI 0-10V AN	86458508-AN	analog	0,6 - 10V	current sink: 100uA-1mA	yes	for flush-type installation boxes	40 x 28 x 15
DALI 0-10V PWM	86458508-PWM	PWM digital	0 - 100% PWM frequency fixed 488Hz	switching current: max. 1mA voltage: max. 10V	yes	for flush-type installation boxes	40 x 28 x 15
DALI PWM 100mA	86458508-100	PWM digital	0 - 100% PWM frequency adjustable: 488Hz / 976Hz	switching current: max. 100mA voltage: max 60VDC	yes	for flush-type installation boxes	40 x 28 x 15

86458508-LE enables the integration of devices that have an integrated galvanic isolation and a 0-10V or 1-10V control input:

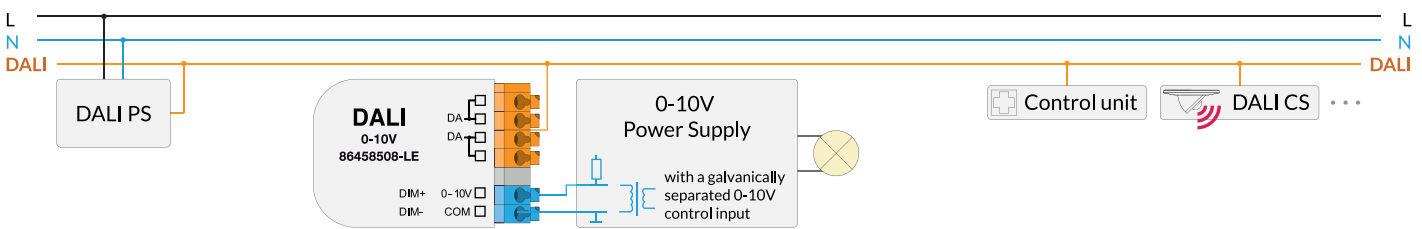

86458508-AN offers a galvanically isolated output and enables the integration of devices with 0-10V or 1-10V control input:

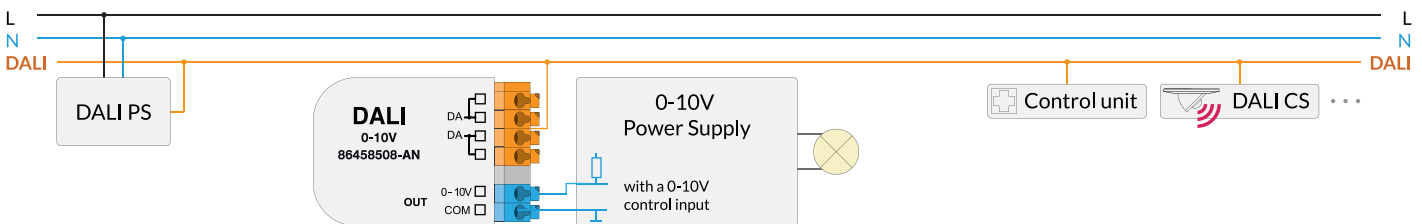

86458508-PWM offers a galvanically isolated output and enables the integration of devices with a PWM control input:

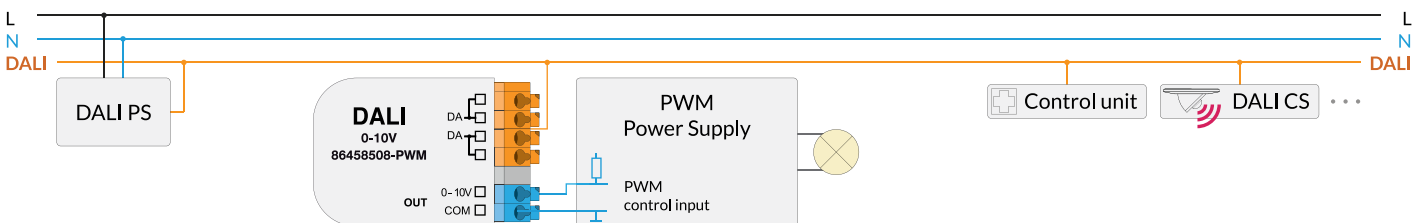

86458508-100 offers a galvanically isolated output and enables the integration of up to 100 devices with PWM control input:

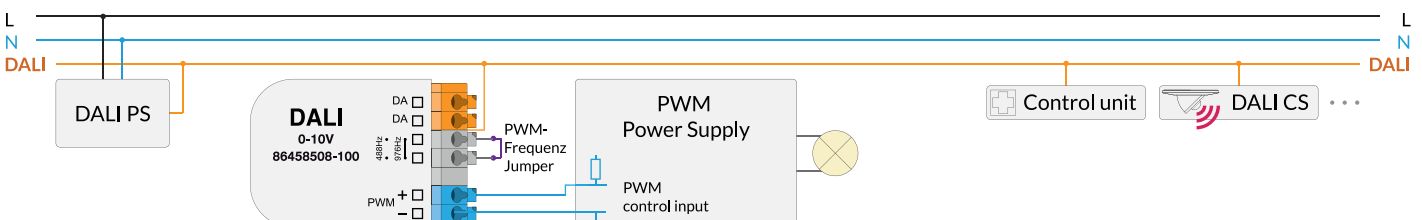

OVERVIEW FOLDER A-E

INPUT DEVICES, CONTROL UNITS & SENSORS

[→ open Folder A](#)

DALI-2 Display 4" and 7"	2	wDALI Switch Cross	18	DALI CDC - time based CW-WW control	27
DALI-2 Display 7" - Emergency	4	wDALI Remote	19	DALI-2 RTC+ Timer	28
DALI-2 Display Bus Extension	5	wDALI MC - wireless pushbutton coupler	20	DALI NFC App - settings configuration	28
DALI-2 Touchpanel	6	DALI-2 MC - pushbutton coupler	20	DALI Daylight Bluetooth Interface	29
DALI Touchpanel	8	DALI-2 MC1L - pushbutton coupler	21	DALI-2 Audio Interface	29
DALI Bluetooth Interface	8	DALI-2 MC4L - pushbutton coupler	22	DALI-2 CS	30
DALI Touchpanel Bluetooth 4.0	9	DALI-2 MC1L PS, MC2L PS	22	DALI-2 CS Integration THP LE	34
DALI-2 KNX Room Controller	10	DALI-2 MC4L POT1 - pushbutton coupler	23	DALI-2 CS Mini	35
DALI-2 Room Controller	10	DALI 100K - interface for potentiometer	23	DALI-2 CS Corridor	36
DALI Cockpit Mobile - smartphone app	11	EnOcean DALI-2 MC	24	DALI CS with 20mA DALI power supply	37
DALI ROT	12	DALI GC(-A) - controlling 2 DALI groups	24	DALI SI, SI-1L	37
DALI-2 ROT	14	DALI SC(-A) - controlling 4 DALI scenes	25	DALI-2 LS - light sensor	38
DALI-2 ROT Touch	16	DALI LR PS 20mA - auto. reduction	25	DALI Temp - temperature sensor	38
DALI-2 Switch Cross NFC	17	DALI-2 Sequencer	26		

PHASE DIMMER, ACTUATORS & SIGNAL CONVERTERS

[→ open Folder B](#)

DALI-2 PD - DALI 230V phase dimmer	2	DALI Jalousie - 230VAC	6	module with 0/1-10V	7
Relay modules RM8 / RM16	3	DALI RM8 / RM16 0-10V - relay modules with		DALI 0/1-10V - converting DALI to 0-10V,	
DALI-2 4Ch PD - 4 channel phase dimmer	4	0-10V input	6	1-10V or PWM	8
DALI-2 4Ch E-RM - 4 channel relay control	4	DALI RM8 / RM16 2x0-10V - for 2 devices		DALI Dim2warm - from DT6 to 2x DT6	9
wDALI RM8 - wireless relay module	5	with 0-10V input	7	DALI DT8 to DT6 - from DT8-Tc to 2x DT6	9
DALI 4Ch RC - 4 channel relay control	5	wDALI RM8 0/1-10V PWM - wireless relay		1Ch LED Booster/Dimmer	10

OPERATING DEVICES 230VAC / 48V / 24V

[→ open Folder C](#)

1-4 Channels, Constant Voltage (CV)	4	CW-WW, RGB, RGBW - Constant Current	9	230V Operating Devices - DALI LED Power	
1-4 Channels, Constant Current (CC)	6	230V Operating Devices - DALI LED Power		Supply - Tunable White DT8, CV-CC	12
CW-WW, RGB, RGBW - Constant Voltage	8	Supply - 1 Channel DT6, CV-CC	11		

DALI BUS POWER SUPPLY & EXTENSION

[→ open Folder D](#)

DALI-2 PS - DALI bus power supply	2	wDALI GR-Transwithter - Receiver PS20	6	DALI 4Net - control of 4 DALI lines	8
DALI-2 Expander - system expansion &		wDALI-2 Bluetooth 5 Long Range		DALI-2 Display Bus Extension	9
DALI power supply	3	Transwithter - Receiver	6	24V DC Power Supply	9
DALI Proxy	5	wDALI-2 Bluetooth 5 wireless Bridge	7		
DALI Repeater	5	wDALI-2 Extra Long Range wireless Bridge	7		

INTERFACES, TOOLS & GATEWAYS

[→ open Folder E](#)

DALI Cockpit - PC software	2	DALI-2 KNX Room Controller	10	0-10V DALI - converting 0-10V to DALI with	
short introduction on commission a DALI		DALI-2 Room Controller	11	30mA bus supply	17
system	2	DALI Cockpit Mobile - Smartphone App	12	4-20mA to DALI Converter - 24V, with	
DALI-2 USB 30mA	4	DALI Daylight Bluetooth Interface	13	30mA bus supply	18
DALI USB	4	DALI-2 Audio Interface	13	4-20mA to DALI Converter - 230V, with	
DALI Flash USB	5	DALI SI, SI-1L	14	30mA bus supply	18
DALI-2 WLAN Cockpit Interface	5	DALI DSI - converting DALI to DSI	14	DALI RM8 / RM16 0-10V	19
DALI 4Net - control of 4 DALI lines	6	DALI Dim2warm - from DT6 to 2x DT6	15	DALI RM8 / RM16 2x0-10V	19
DALI-2 SCI RS232	7	DALI DT8 to DT6 - from DT8-Tc to 2x DT6	15	wDALI RM8 0/1-10V PWM - wireless	20
DALI-2 RS232 PS - with DALI bus supply	7	0-10V DALI - converting 0-10V to DALI with		DALI Yeslousie - 230VAC	20
DALI-2 IoT Gateway	8	10mA bus supply	16	DALI 0/1-10V - converting DALI to 0-10V,	
KNX DALI-2 Gateway	9	0-10V DALI - converting 0-10V to DALI with		1-10V or PWM	21
KNX 4 DALI Gateway	10	1, 2 or 3 channels	17		

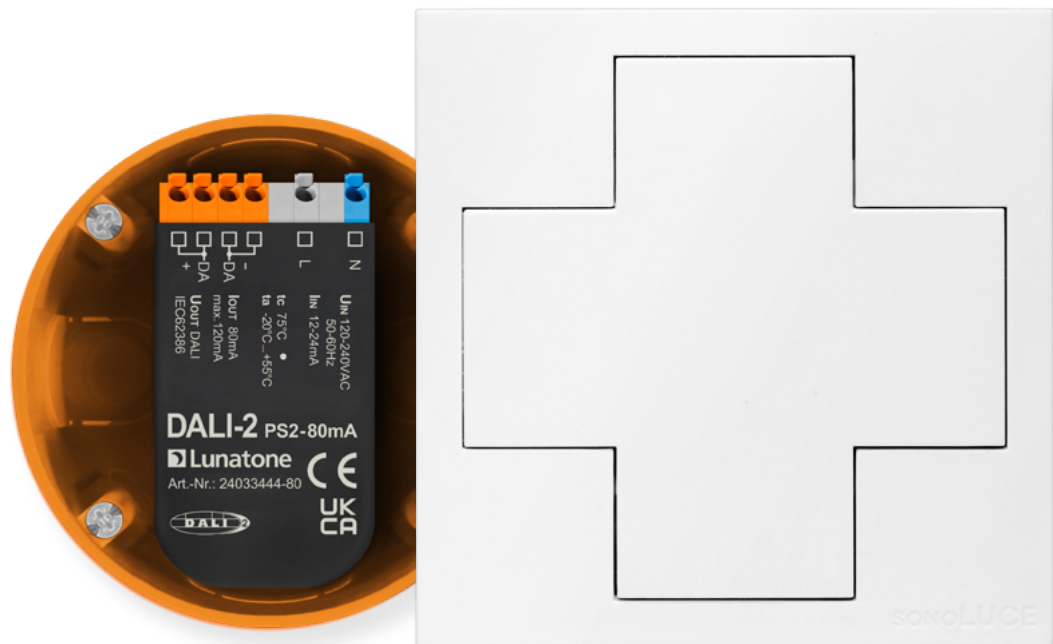

Lunatone

www.lunatone.com

Lunatone Industrielle Elektronik GmbH
 Paukerwerkstrasse 5
 1210 Vienna, Austria
 Tel: +43 1 2026400
 E-Mail: office@lunatone.com

Lunatone Lighting GmbH
 Hintere Achmühlerstrasse 1,
 6850 Dornbirn, Austria
 Tel: +43 5572 205050
 E-Mail: lighting@lunatone.com

Subject to alterations; errors and printing errors excepted.
 Copyright 2024 Lunatone Industrielle Elektronik GmbH